

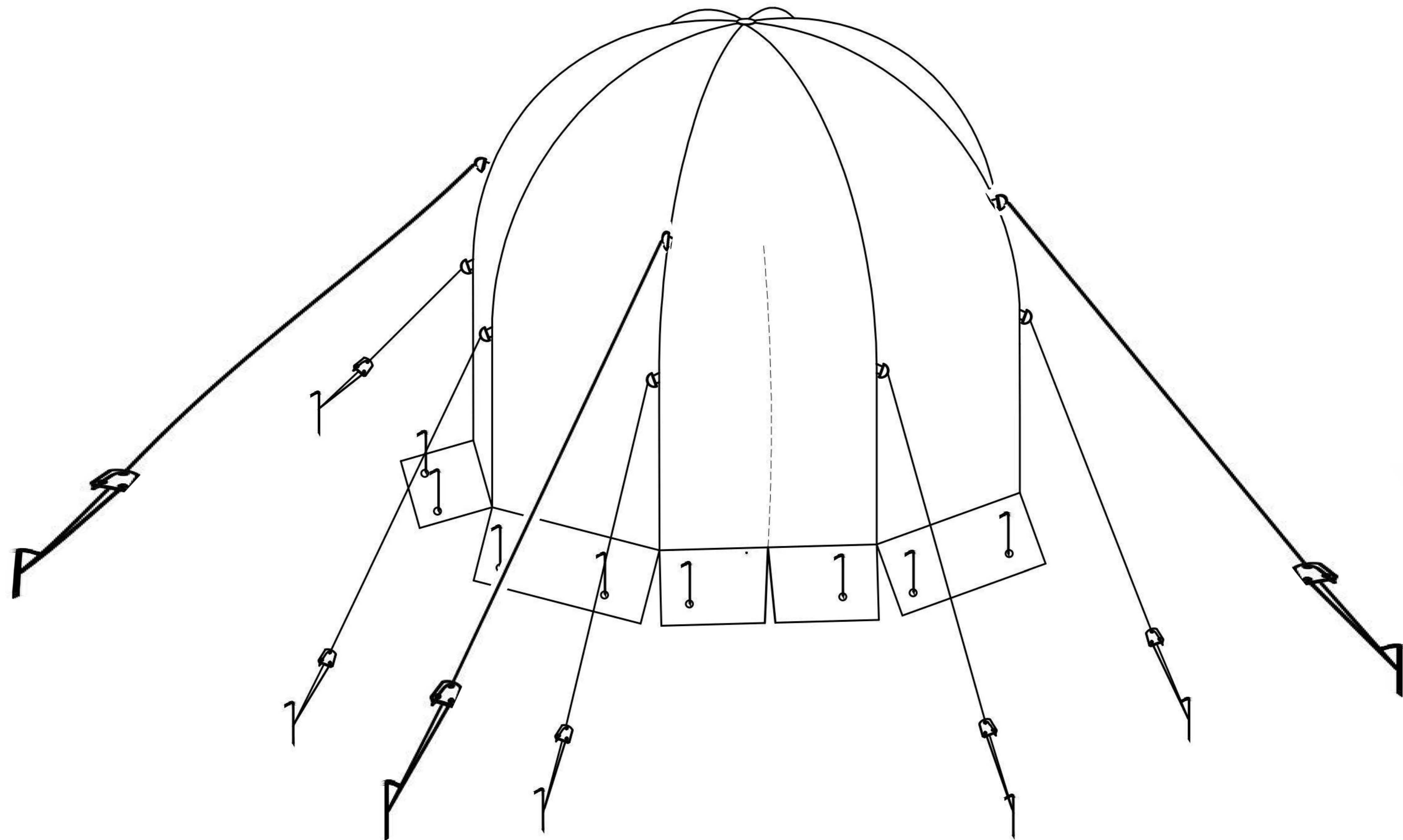

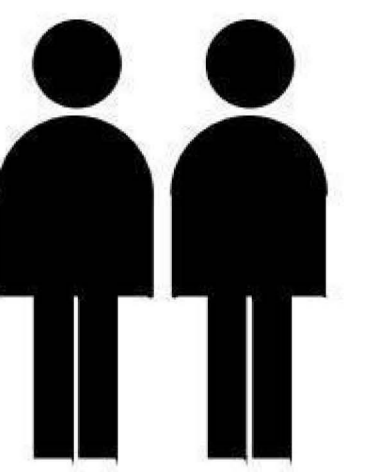

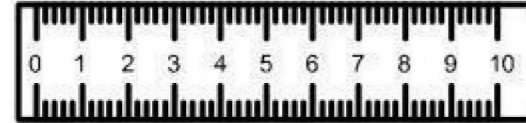

D 3.8m x H 3.5m

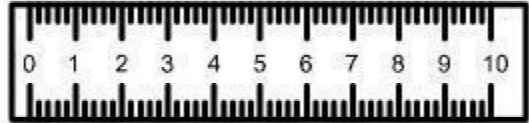
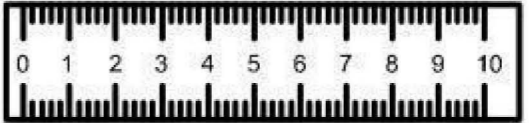
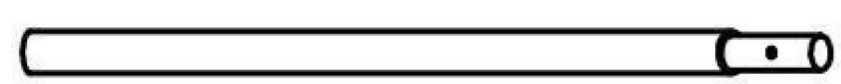
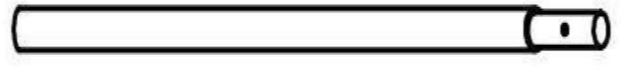
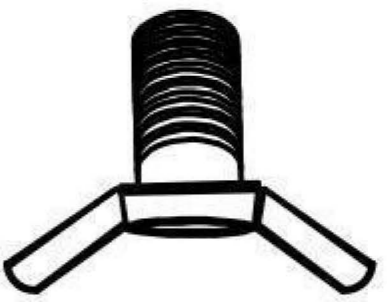

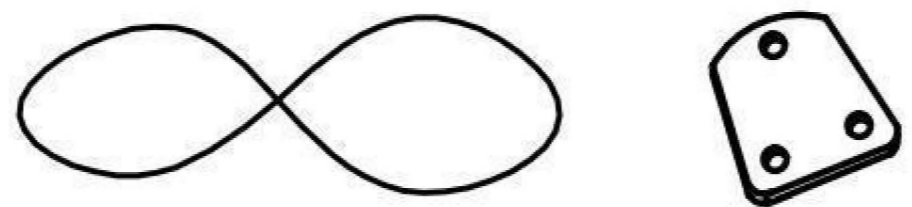
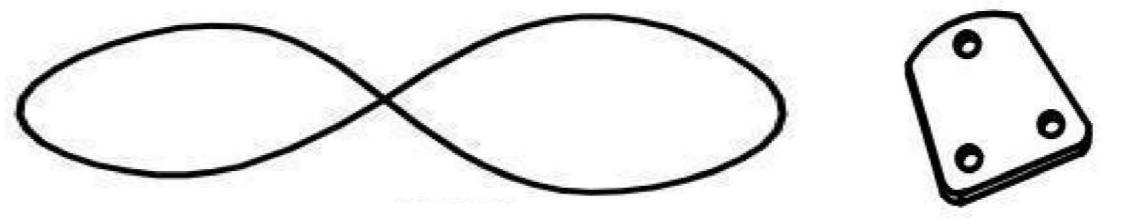
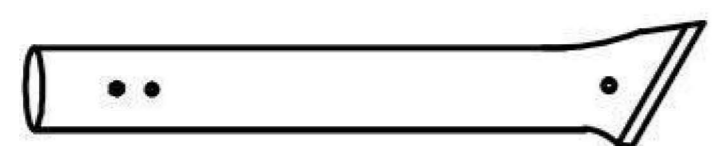
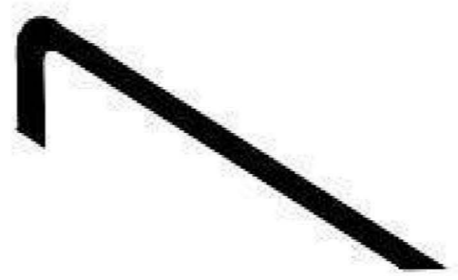
#	 MM	x	#	 MM	x	#	 MM	x
1		8x	5		8x	9		8x
2		24x	6		8x	10		4x
3		8x	7		8x	11		4x
4		1x	8		16x	12		1x

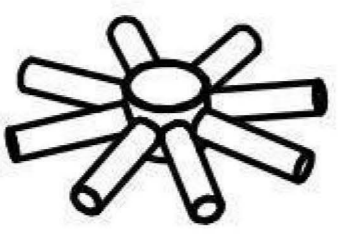
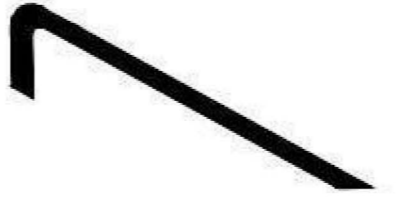
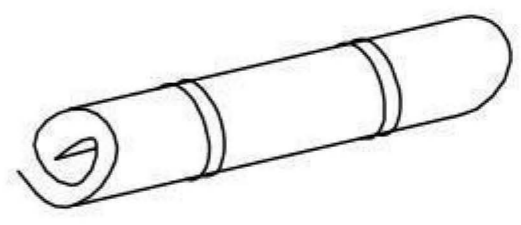
①

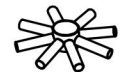
NO.	DRAWING	Q' TY
2		8
4		1

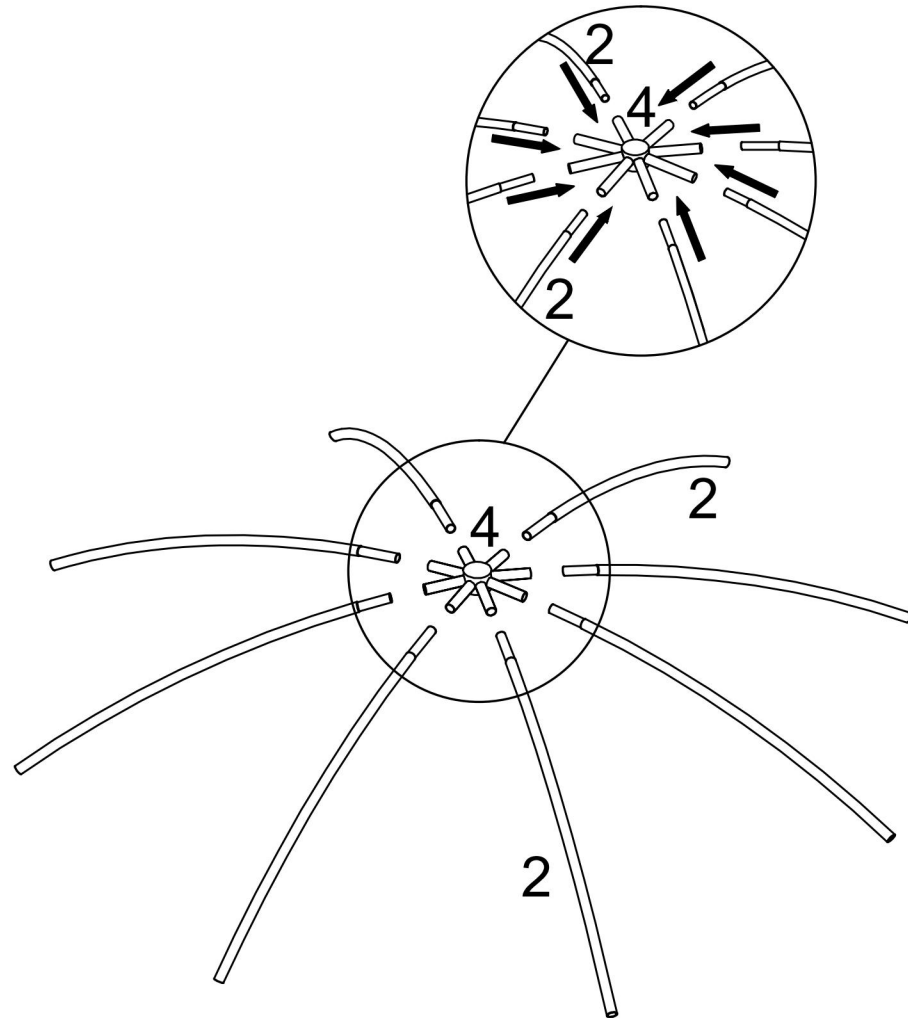

②

NO.	DRAWING	Q' TY
2		16

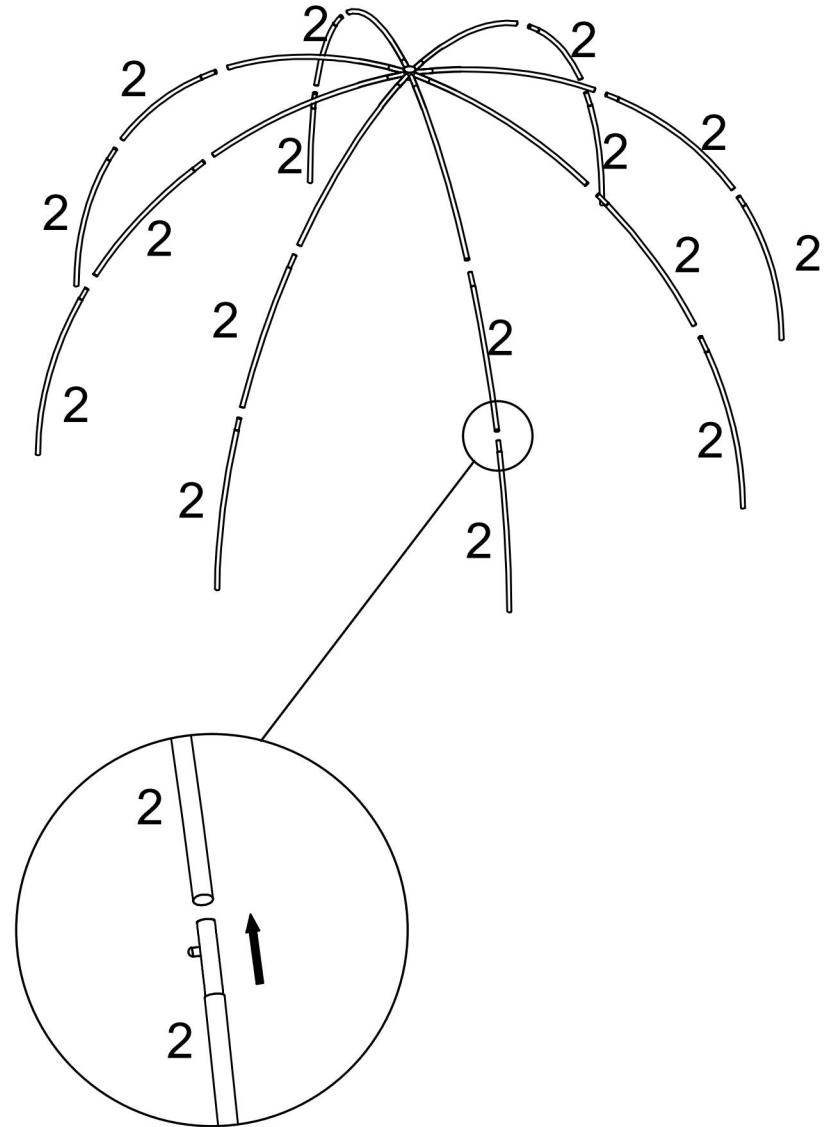

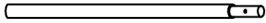

3

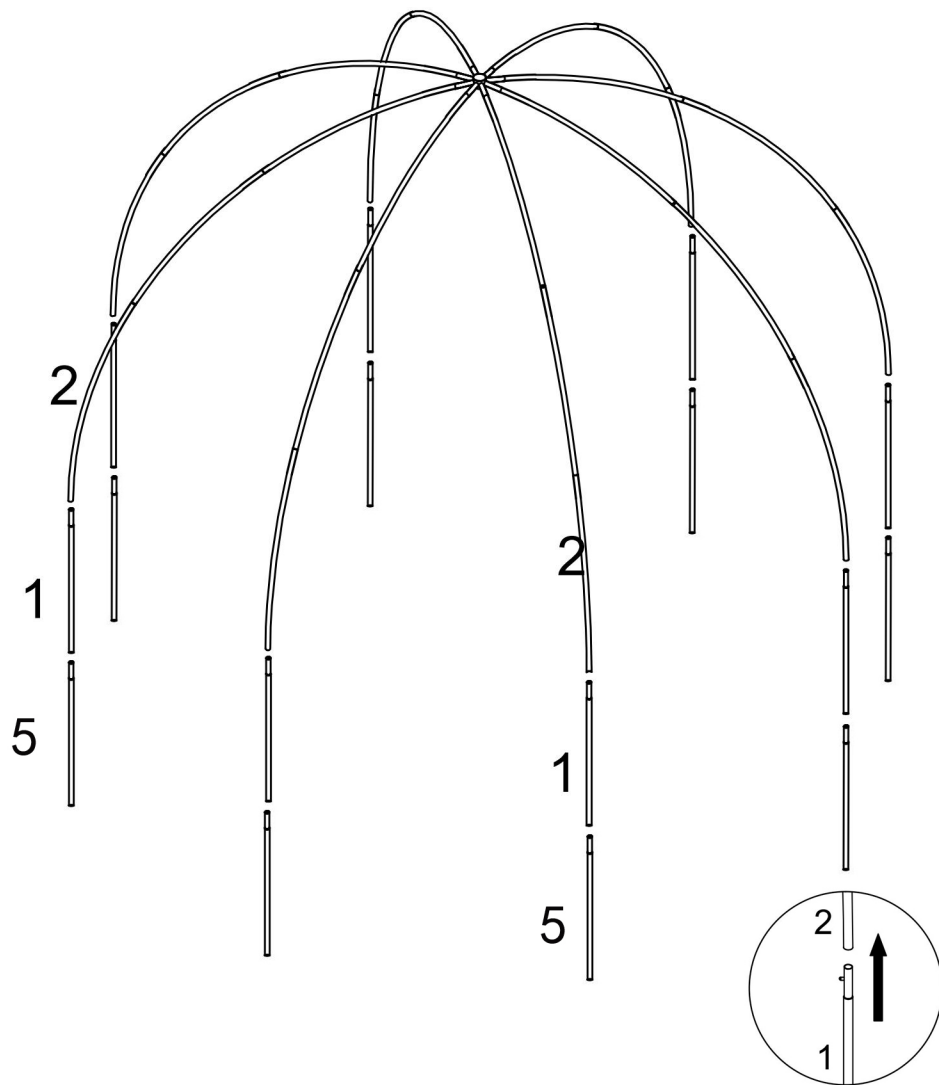
NO.	DRAWING	Q' TY
1		8
5		8

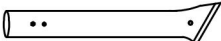

4

NO.	DRAWING	Q' TY
3		8
9		8

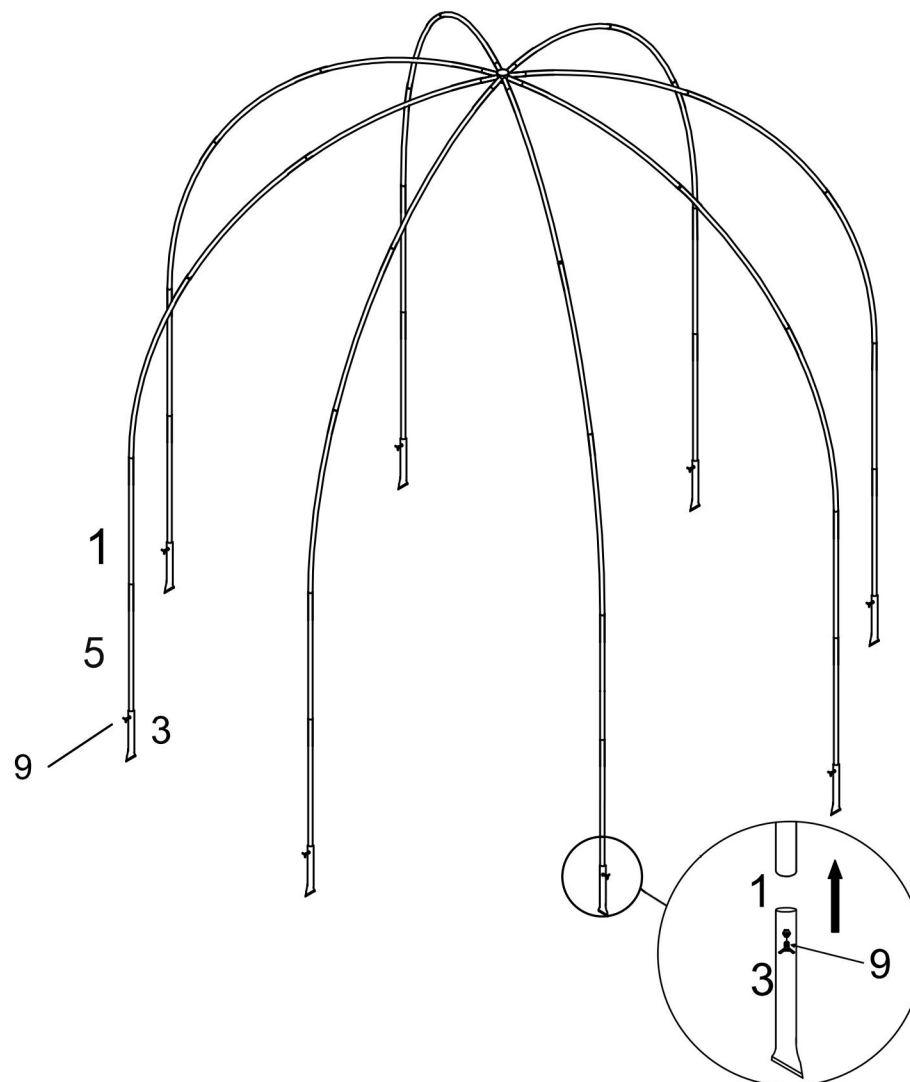

5

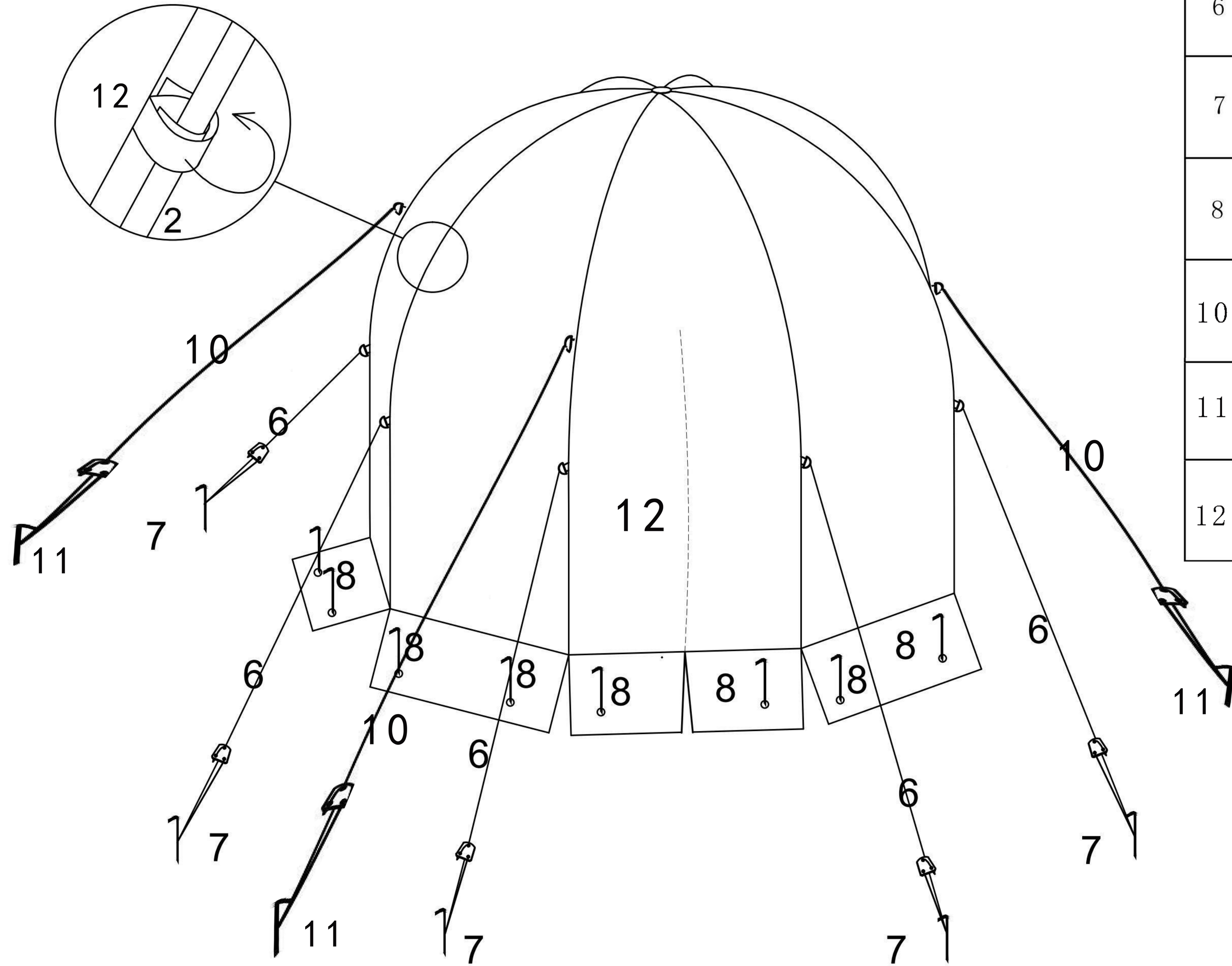

NO.	DRAWING	Q' TY
6		8
7		8
8		16
10		4
11		4
12		1