



DE Aufbauanleitung „Komposter“

- Ⓞ GB Assembly manual for “Composter”
- Ⓞ FR Notice de montage du “Composteur”
- Ⓞ NL Opbouwbeschrijving voor “CompostBox”
- Ⓞ ES Instrucciones de montaje de “Compost”
- Ⓞ IT Istruzioni di montaggio “Compostiera”
- Ⓞ DK Monteringsvejledning for “Kompostbeholder”



 Poišćite vař prevod na ...

 Najděte svůj překlad ...

 Hitta din översättning ...

 Finn din oversettelse ...

 Találja meg fordítását ...



Wichtige Punkte für den Aufbau!

Vorliegende Aufbauanleitung zeigt den Zusammenbau für einen „Komposter“. Für einige Montageschritte benötigen Sie einen Helfer.

- GB *Important details regarding assembly! The available assembly manual shows the installation of the “Composter”. For several assembly steps additional assistance of one person will be required.*
- FR *Points importants lors du montage! „Cette notice de montage décrit l’assemblage du „composteur“. Pour certaines étapes, demandez l’aide d’une ou deux personnes.*
- NL *Deze opbouwbeschrijving toont de opbouw van de Compostbak. Bij enkele stappen tijdens de opbouw heeft u een 2e persoon nodig.*
- ES *Notas importantes para el montaje: Estas instrucciones de montaje muestran el ensamblaje de un „compostador“. Es recomendable realizar el montaje entre dos personas.*
- IT *La presente istruzione di montaggio dimostra il montaggio di una „compostiera ». Per alcune fasi di assemblaggio vi servirà qualche aiutante.*
- DK *Denne vejledning viser samling af „Kompostbeholder“. Ved flere punkter af opsætningen er yderligere hjælp påkrævet af 1 eller 2 personer.*



Um Kratzer zu vermeiden, verwenden Sie bitte geeignete Unterlagen!

- GB *Please use a suitable underlay to avoid scratches!*
- FR *Pour éviter les rayures, utilisez les supports appropriés!*
- NL *Om krassen te voorkomen raden wij u aan er iets onder te leggen!*
- ES *Por favor, coloque en el suelo una base protectora adecuada para evitar posibles arañazos.*
- IT *Utilizzare una base adatta per evitare graffi!*
- DK *Benyt venligst et passende underlag for at undgå skrammer!*



Wasserwaagen - Symbol:

Betreffendes Einbauteil mit der Wasserwaage ausrichten.

- GB *Symbol of spirit level: Align the respective parts by using the spirit level.*
- FR *Symbole niveau à bulle: Lorsque ce symbole apparaît, vous devez ajuster l’élément à l’aide d’un niveau à bulle.*
- NL *Waterpas - symbol: Bij montageschappen waar dit symbool bijstaat is het noodzakelijk het betreffende onderdeel waterpas in te bouwen.*
- ES *Símbolo del nivelador: Indica que se debe ajustar y centrar la pieza con la ayuda de un nivelador.*
- IT *Simbolo di livella a bolla d’aria: Allineare il componente in questione con l’ausilio di una livella a bolla d’aria.*
- DK *Symbol for vaterpas: Juster de respektive dele ved hjælp af vaterpas.*

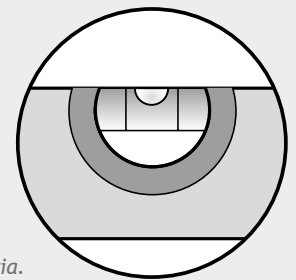

Verwenden Sie bei der Montage Arbeitshandschuhe!

- GB *Wear working gloves!*
- FR *Portez des gants de travail*
- NL *Handschoenen gebruiken!*
- ES *Utilice unos guantes de trabajo.*
- IT *Utilizzare guanti da lavoro*
- DK *Brug arbejdshandsker!*



Magnetische Bauteile!

Das Magnetfeld eines Dauermagnets kann elektronische und mechanische Geräte beeinflussen oder sogar beschädigen. Magnetfelder können die Funktion von Herzschrittmachern und implantierten Defibrillatoren beeinflussen.

- GB *The magnetic field of a permanent magnet can affect or even damage electronic and mechanical devices. Magnetic fields can affect the function of pacemakers and implanted defibrillators.*
- FR *Le champ magnétique d’un aimant permanent peut influencer ou même endommager les dispositifs électroniques et mécaniques. Les champs magnétiques peuvent influencer le fonctionnement des stimulateurs cardiaques et des défibrillateurs implantés.*
- NL *Het magnetisch veld van een permanente magneet kan elektronische en mechanische apparaten beïnvloeden of zelfs beschadigen. Magnetische velden kunnen de werking van pacemakers en geïmplanteerde defibrillators beïnvloeden.*
- ES *El campo magnético de un imán permanente puede influir o incluso dañar los dispositivos electrónicos y mecánicos. Los campos magnéticos pueden influir en la función de los marcapasos y los desfibriladores implantados.*
- IT *Il campo magnetico di un magnete permanente può influenzare o addirittura danneggiare i dispositivi elettronici e meccanici. I campi magnetici possono influenzare la funzione dei pacemaker e dei defibrillatori impiantati.*
- DK *Magnetfeltet på en permanent magnet kan påvirke eller endda skade elektroniske og mekaniske enheder. Magnetiske felter kan påvirke funktionen af pacemakere og implanterede defibrillatorer.*



Maßstabsgetreue Abbildungen der zu verwendenden Schrauben:

- GB *Scale drawing 1:1 of the screws in use*
- FR *Reproduction selon l’échelle 1:1.*
- NL *Afbeelding : schaal 1:1 (ware grootte)*
- ES *Reproducción a escala 1:1 de los tornillos que se utilizan para el montaje.*
- IT *Riproduzione in scala 1:1 delle viti da utilizzare.*
- DK *Skala tegning af skruer er 1:1*

M 1:1

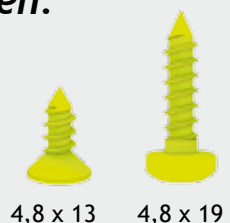

4,8 x 13

4,8 x 19

Pflege und Wartung

- Keine aggressiven Chemikalien wie z.B. Chlor oder Streusalz lagern!
- Sonnenmilch und andere Cremes mit Wasser und Seife entfernen
- Keine scheuernden Reinigungsmittel verwenden!

(NL) Onderhoud

- Geen chemicaliën in de Moestuinbox!
- Zonnebrandolie/melk en andere cremes met water en zeep verwijderen!
- Gebruik geen schuurmiddelen!

(DK) Pleje og vedligeholdelse

- Opbevar ikke aggressive stoffer dvs. Klor eller vejsalt!
- Fjern solcreme eller andre typer af creme med vand og rensmiddel!
- Brug ikke aggressive rengøringsmidler!

(GB) Care and maintenance

- Do not store aggressive substances i.e. chlorine or road salt
- Remove suntan lotion or any other creams with water and soap!
- Do not use abrasive cleaning agents!

(ES) Cuidado y mantenimiento

- No almacene productos químicos agresivos dentro del Huerto Urbano, como por ejemplo cloro y sal antiescarcha.
- Evite dejar huellas o restos de cremas solares sobre la chapa. Limpie al arcón siempre con agua o un trapo húmedo.
- No utilice ningún producto para fregar. En general, evite siempre cualquier producto químico para limpiar al arcón.

(FR) Entretien et maintenance

- Ne pas stocker de produits chimiques (chlore, sel, etc...)
- Nettoyez les traces de crème solaire ou autre uniquement avec de l'eau et du savon
- Ne pas utiliser de produits nettoyant abrasifs!

(IT) Manutenzione

- Non lasciare prodotti chimici aggressivi (come ad esempio cloro o sale per strade) all'interno della Aiuola rialzata!
- Rimuovere crema solare e altre creme con acqua e brillantante!
- Non utilizzare detergenti contenenti sostanze aggressive!

Teileübersicht

parts list · liste des pièces · stuklijst · lista de piezas · lista de parti · deloversigt

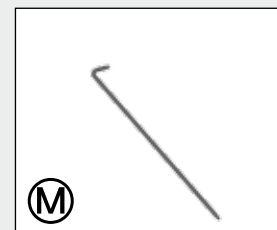
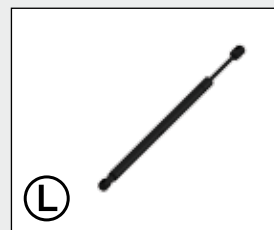
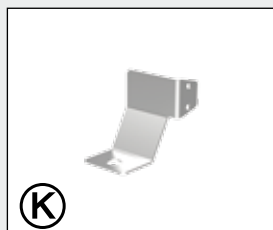
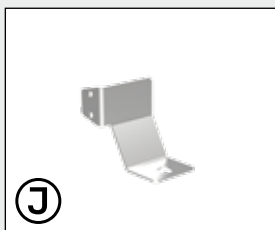
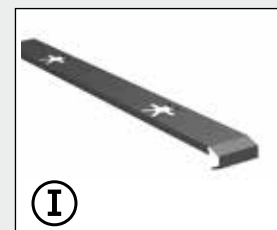
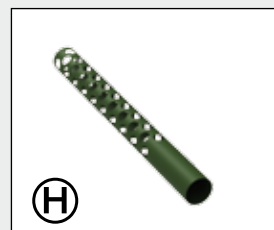
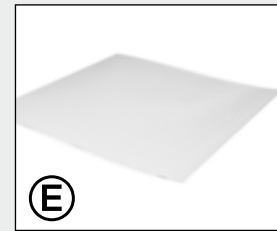
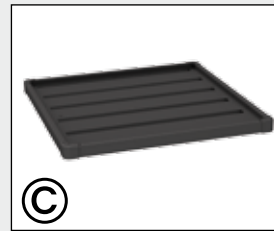
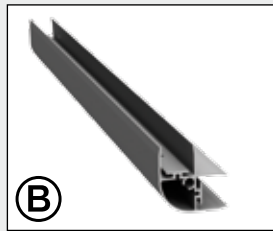
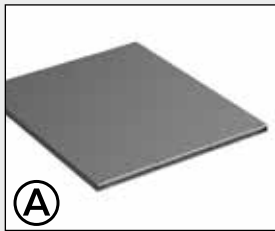

1.

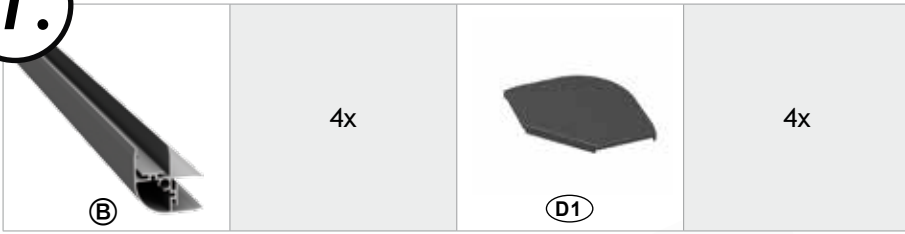

2.

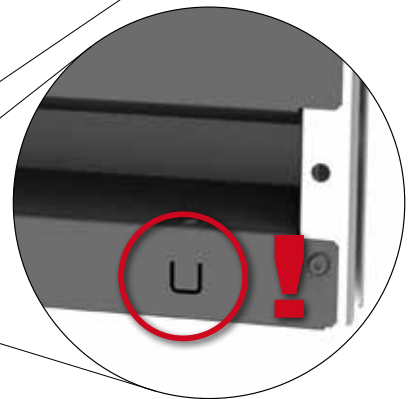
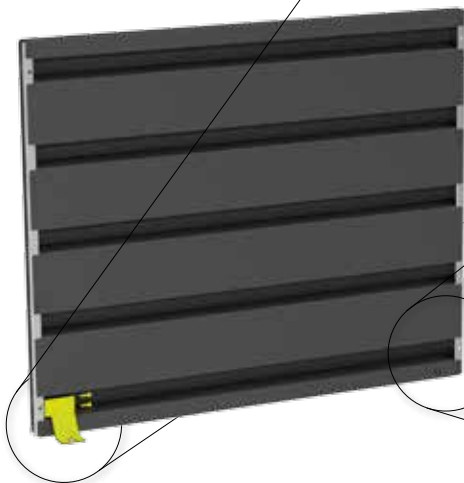
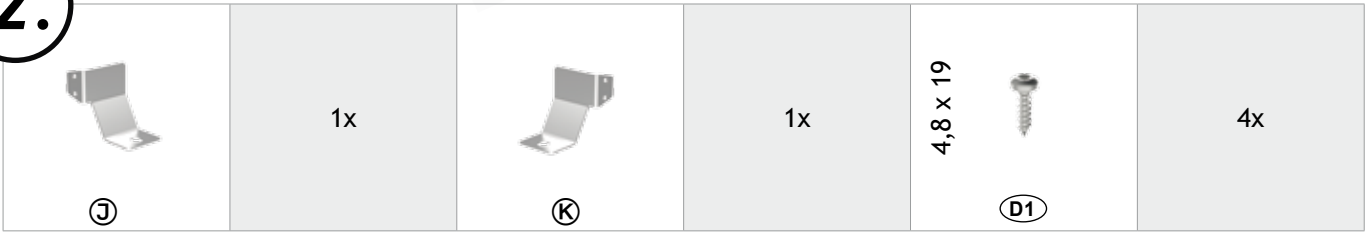

3.

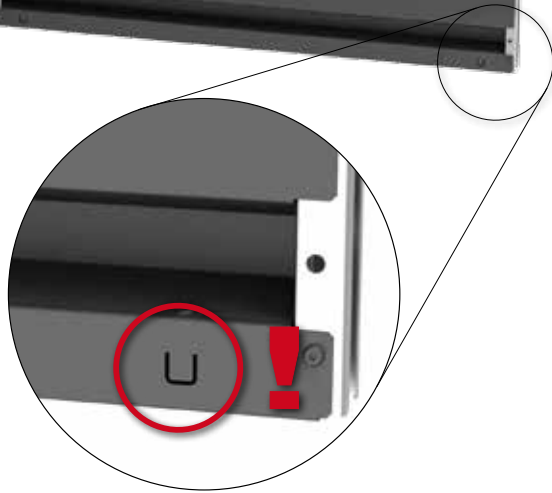
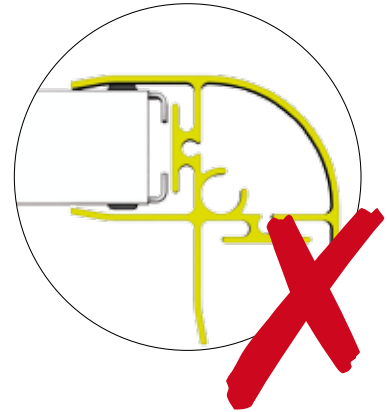
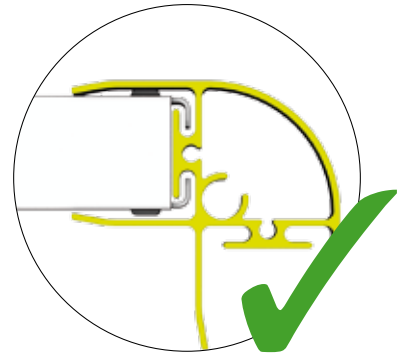
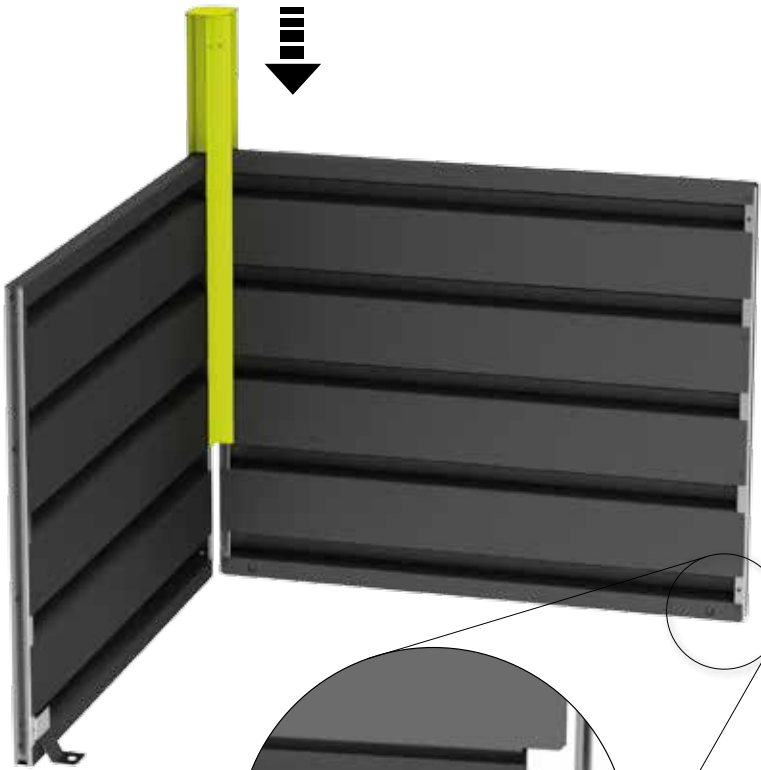
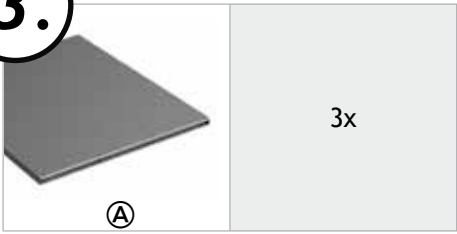

4.

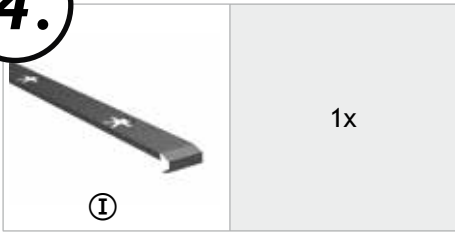

Option:



5.

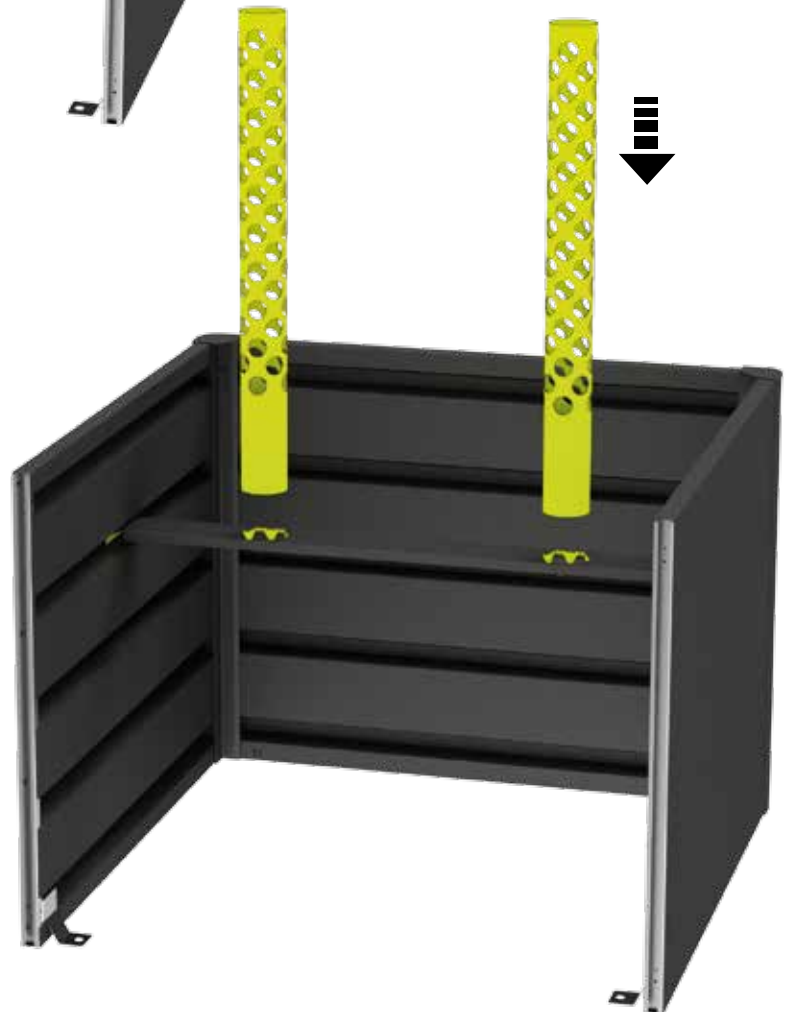
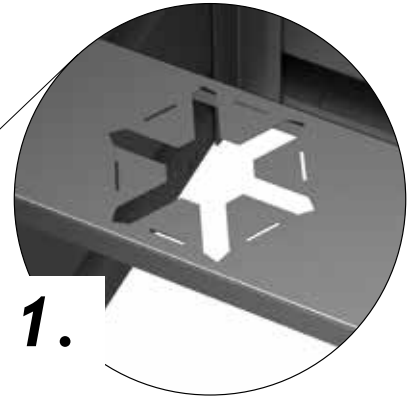
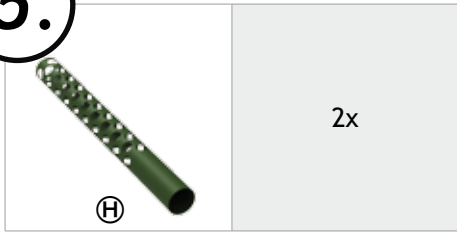

6.



A

1x

4,8 x 19



D1

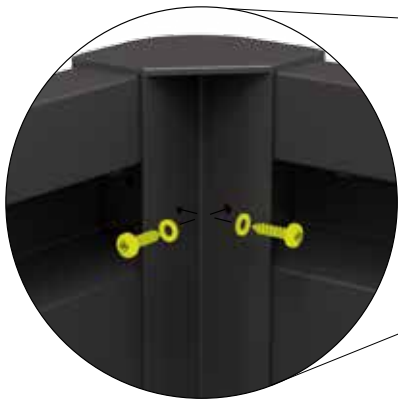

8x

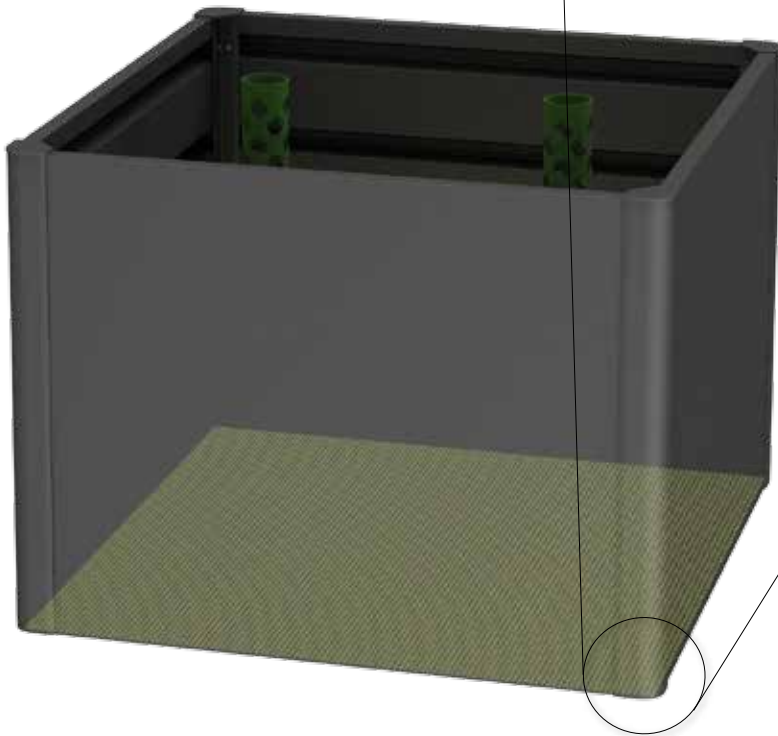
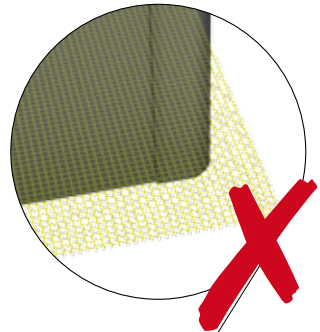
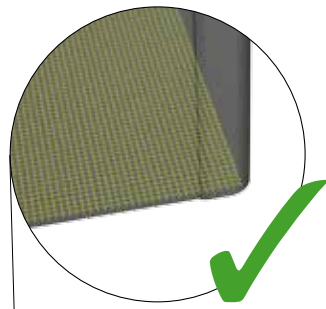
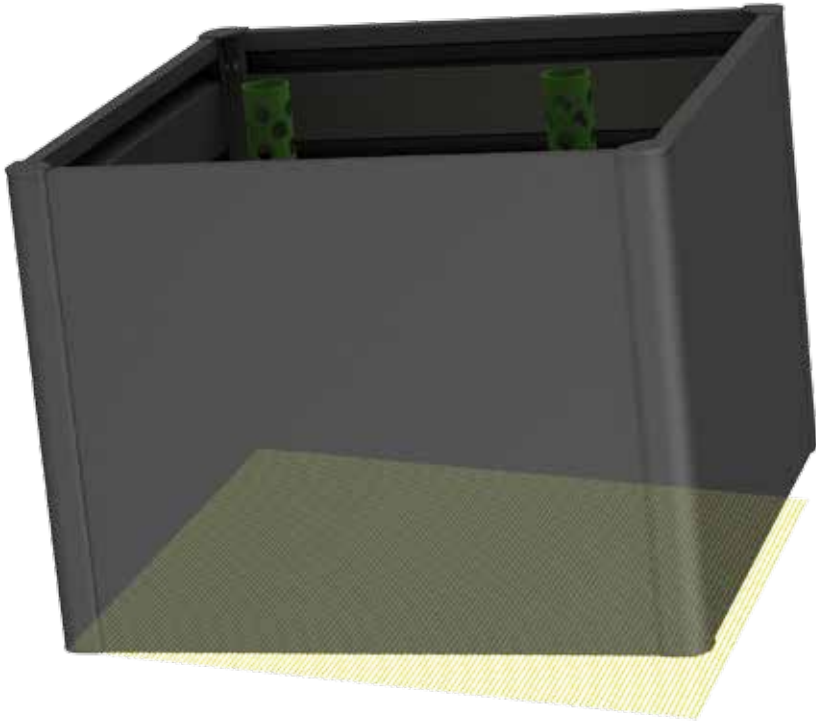
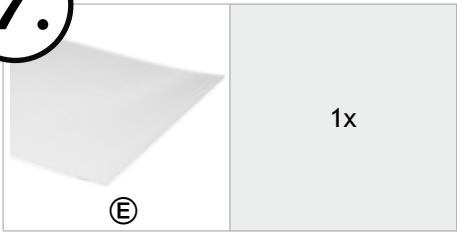

7.





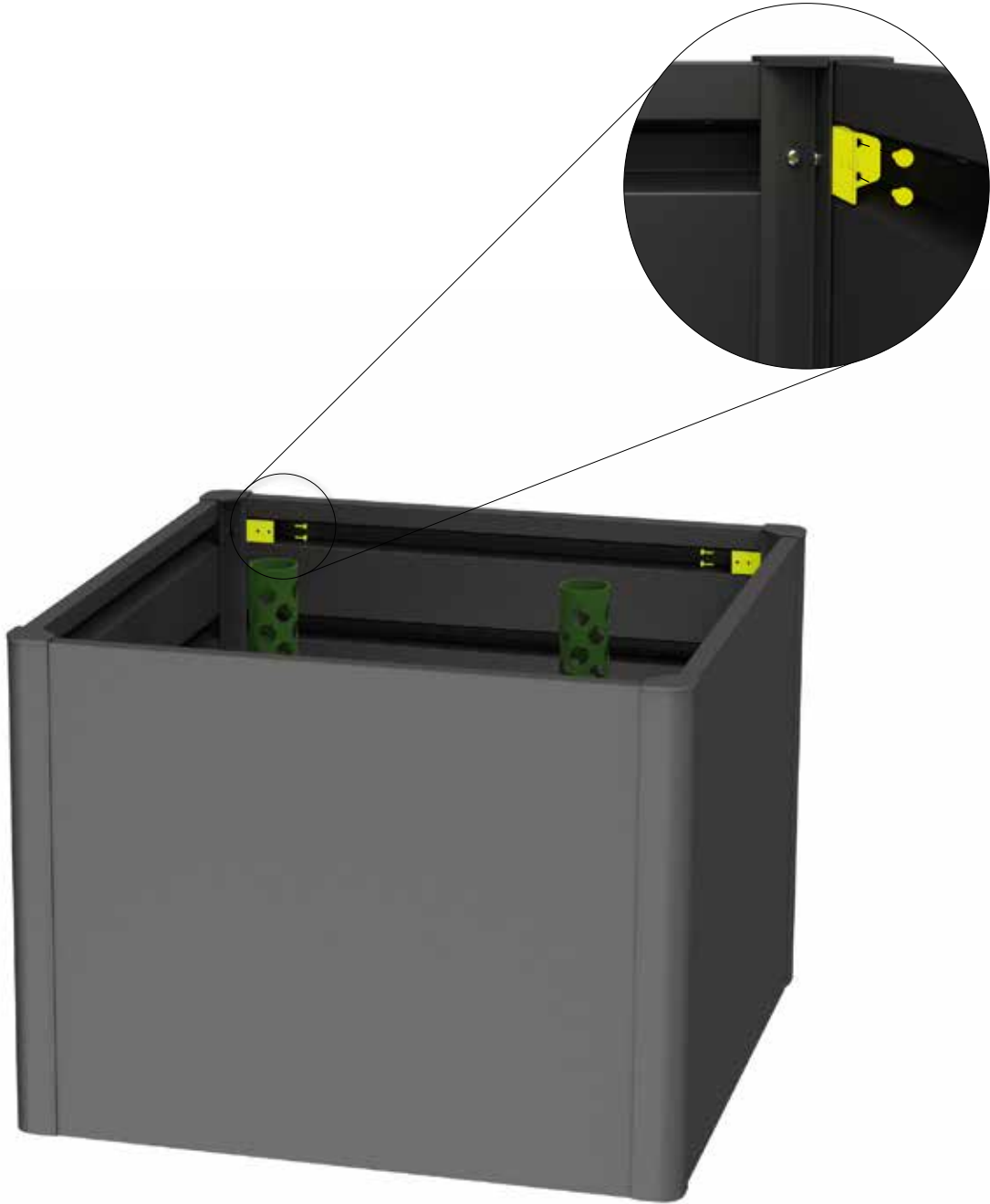

8.

 D1	2x	4,8 x 19  D1	4x
---	----	---	----



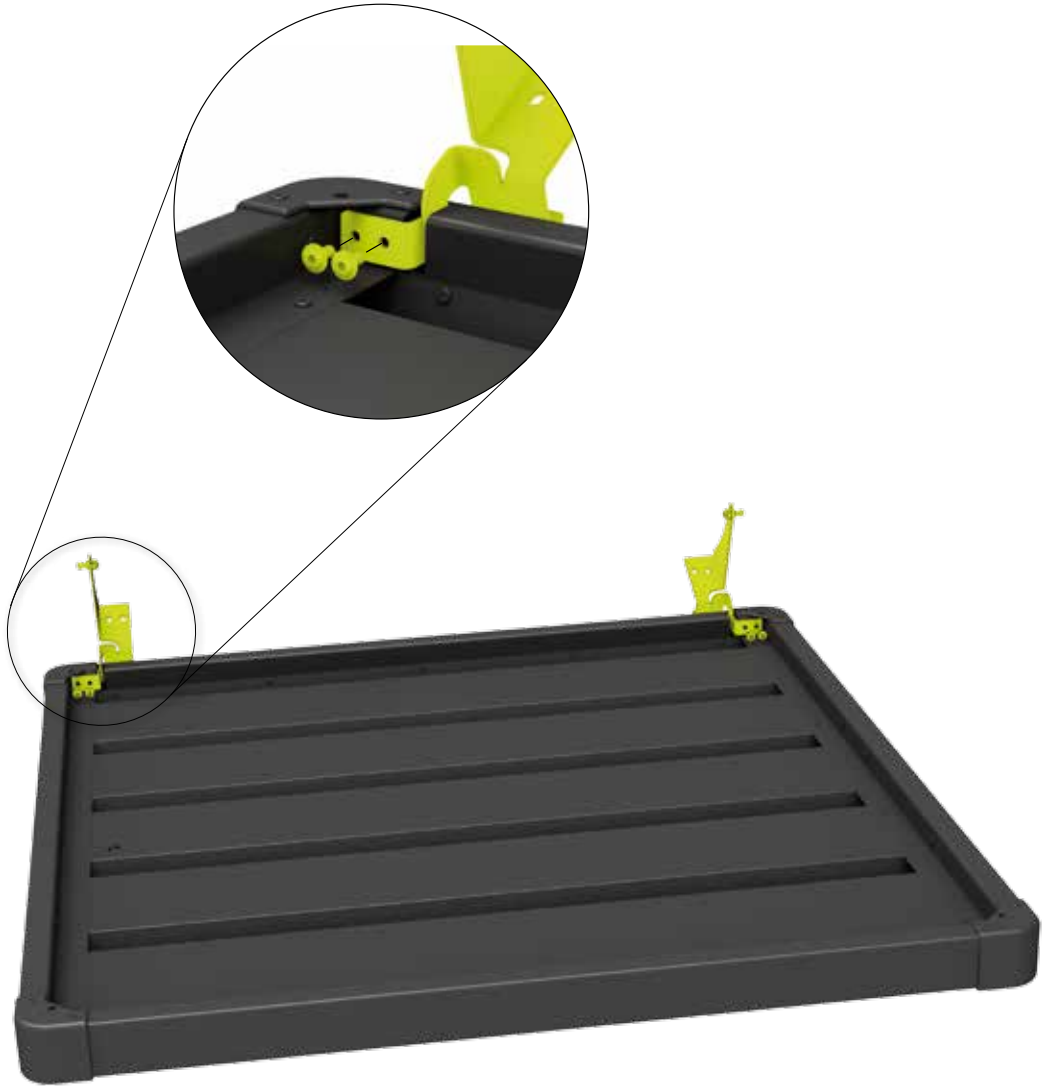

9.

 C	1x	 F	1x	 G	1x
M6 x 12  D1	4x				



10.

	4x		2x		2x
D1		D1		L	

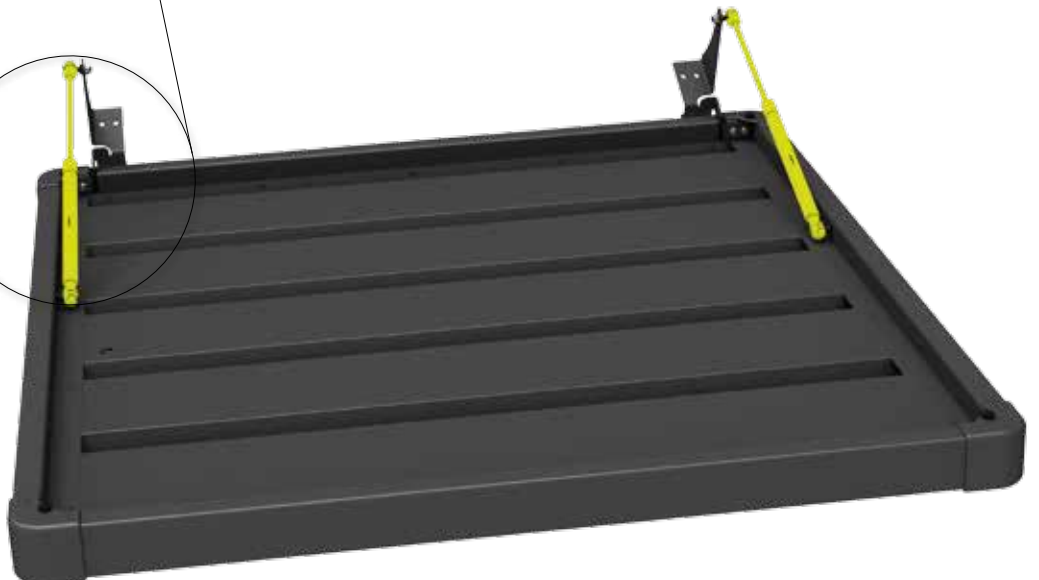
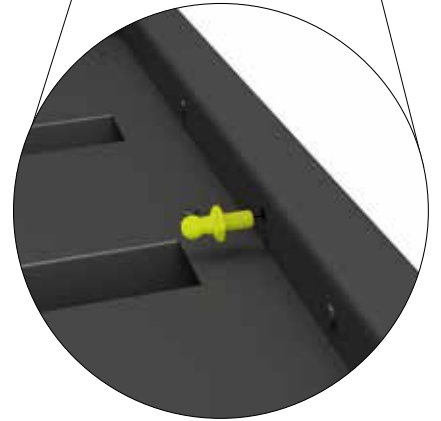
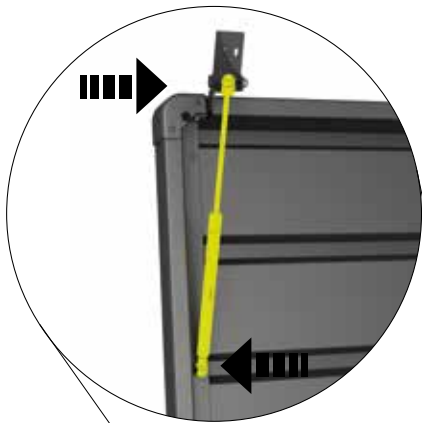
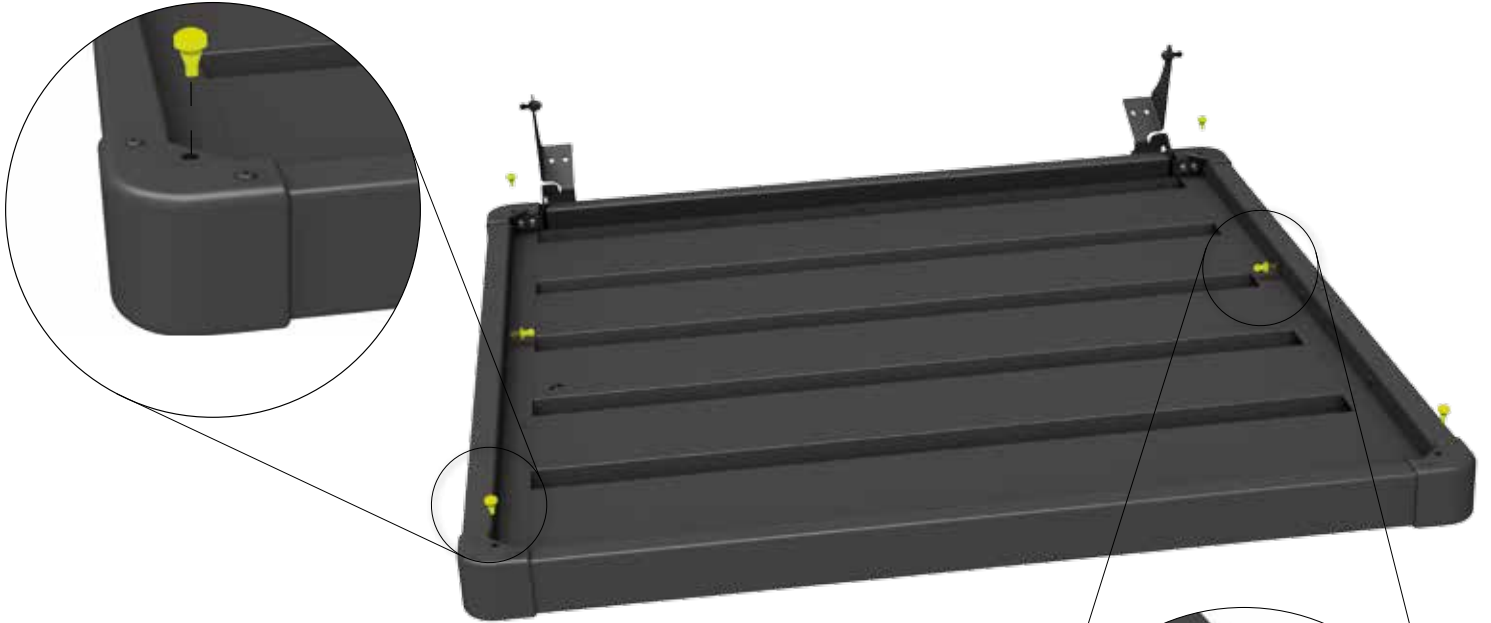

11.

M6 x 12



D1

4x

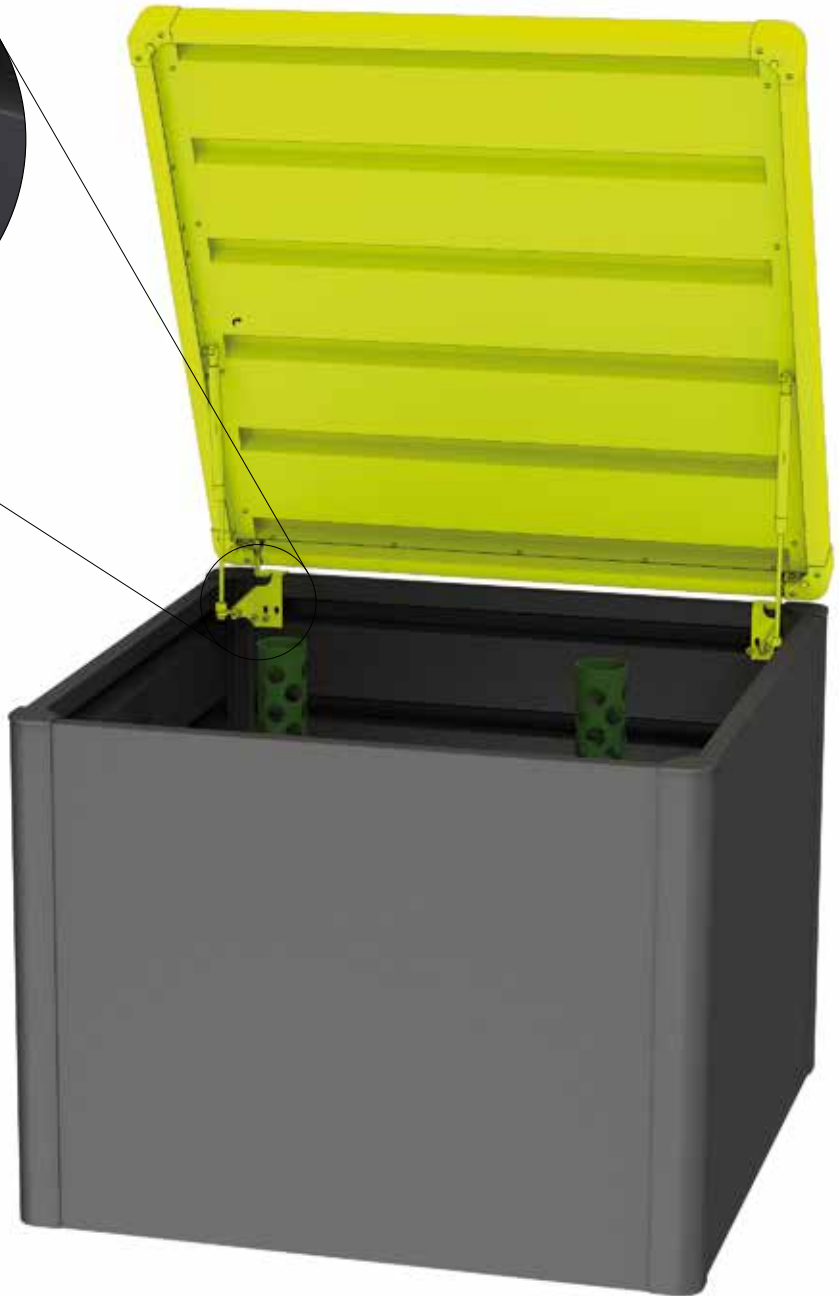

12.

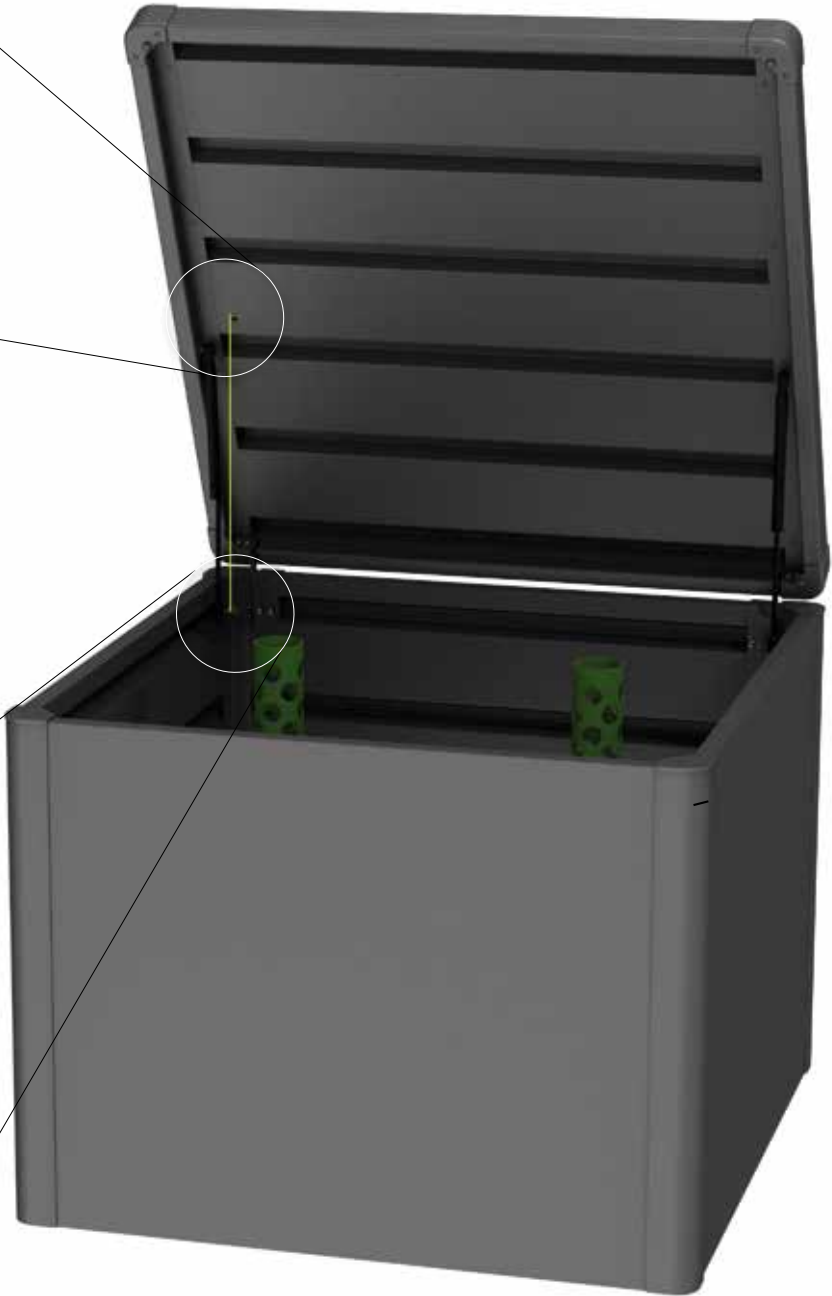
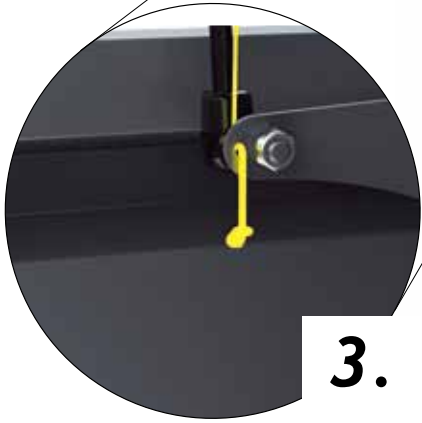
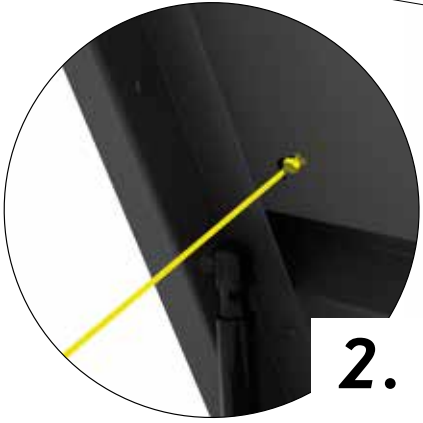
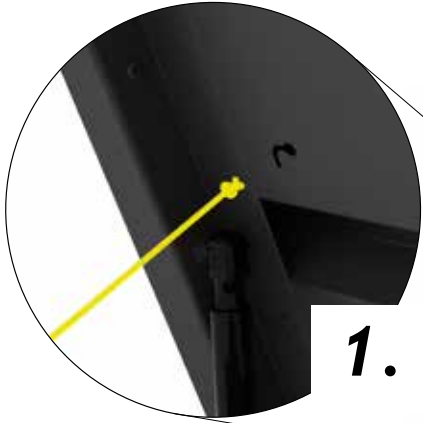
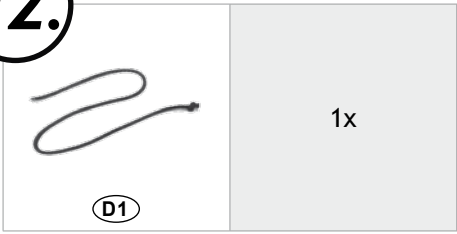

13.

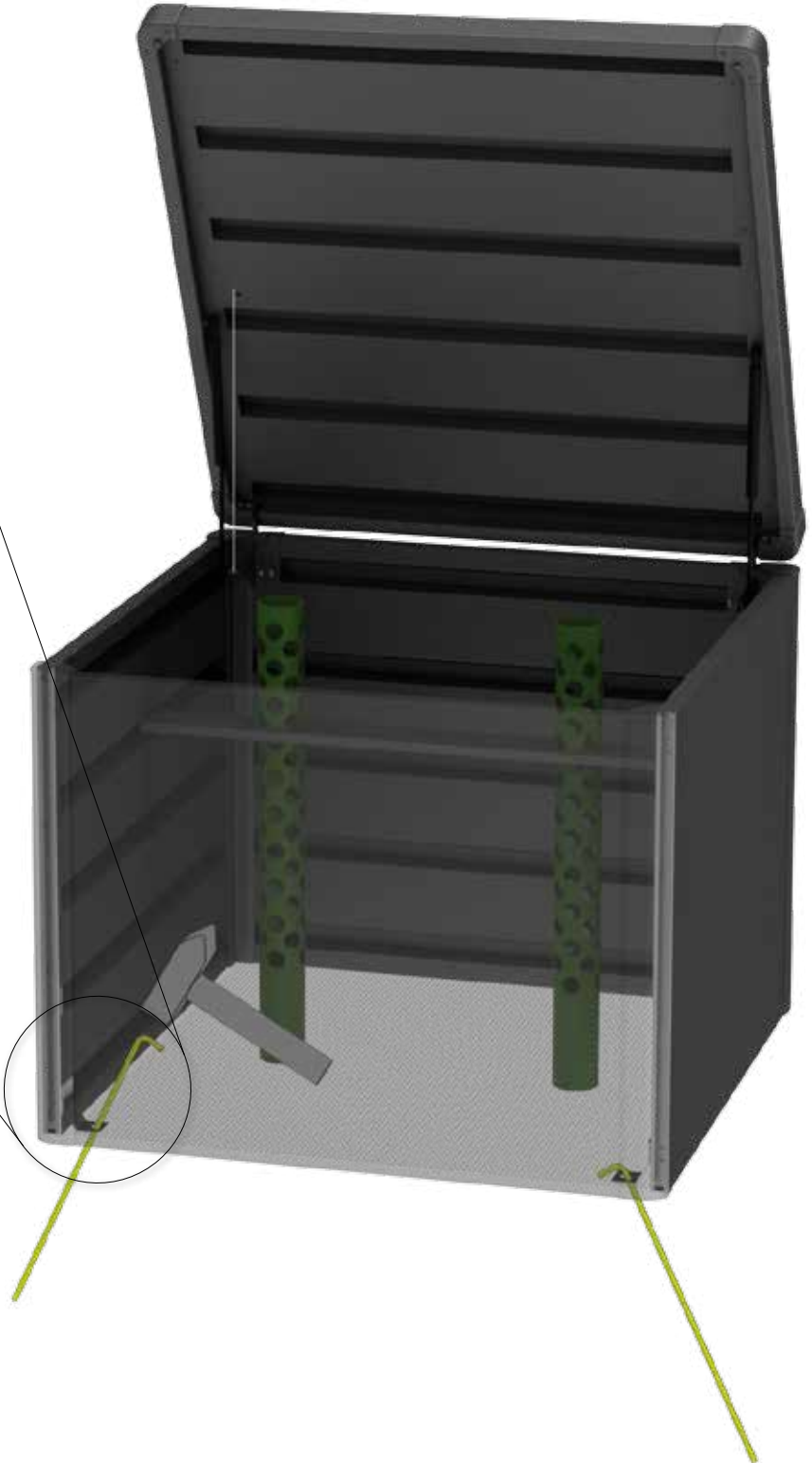
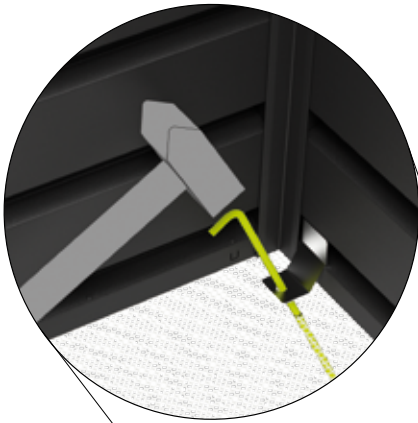
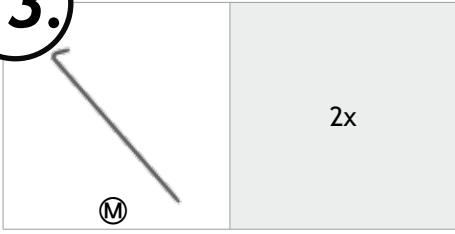



HighLine®

Das ultimative Gerätehaus, das hinsichtlich Sicherheit und Funktionalität alle Anforderungen erfüllt.



Panorama®

Dieses Satteldachmodell passt in jedes Gartenpanorama. Stabilität und Design für höchste Ansprüche.



AvantGarde®

Passt bestens zu moderner Architektur und macht lebenslang Freude.



Europa

Alles in bester Ordnung und lebenslange Wartungsfreiheit mit dem Biohort-Klassiker.



Geräteschrank

Wo Raum knapp ist, zeigt er seine Klasse – im Garten, auf der Terrasse, in der Garage.



MiniGarage

Multifunktionales Stauraumwunder ohne Genehmigungspflicht.



WoodStock®

Kaminholzlager und Geräteschrank in einem, auch zum einfachen Wand-Anbau geeignet.



StoreMax®

Funktionelles Design für maximalen Stauraum auf wenig Platz.



HighBoard

Das formvollendete Multitalent zum Aufbewahren. Mit Flügeltüren und Deckelöffnung.



CornerBoard

Bietet wertvollen Platz auf Balkon und Terrasse.



LoungeBox®

Die Design-Box für gehobene Ansprüche - ein Schmuckstück für Terrasse und Garten.



FreizeitBox

Ideal zum Verstauen von Sitzkissen, Sonnenliegen und Spielzeug.



HochBeet

Schönste Aussicht auf beste Ernte.



Pflanzbeet Belvedere®

Der Blickfang für die Terrasse.



Komposter MonAmi®

Vereint Zweckmäßigkeit mit stilvollem Auftreten.

EXTRA PROSPEKT
anfordern unter
www.biohort.com



Nebengebäude CasaNova®

Design, das sich Ihren Wünschen anpasst.



Biohort GmbH

Pürnstein 43, 4120 Neufelden, Österreich
Tel.: +43-7282-7788-0, Fax-DW: 190
E-Mail: office@biohort.at, www.biohort.com

