

Polycarbonat mit der bedruckten Folie auf der Aussenseite montieren. Nach der fertigen Montage die Folie entfernen.

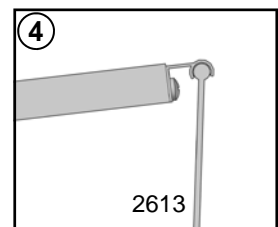

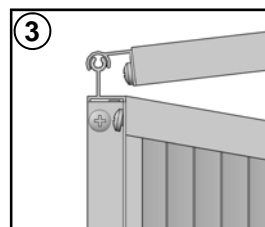
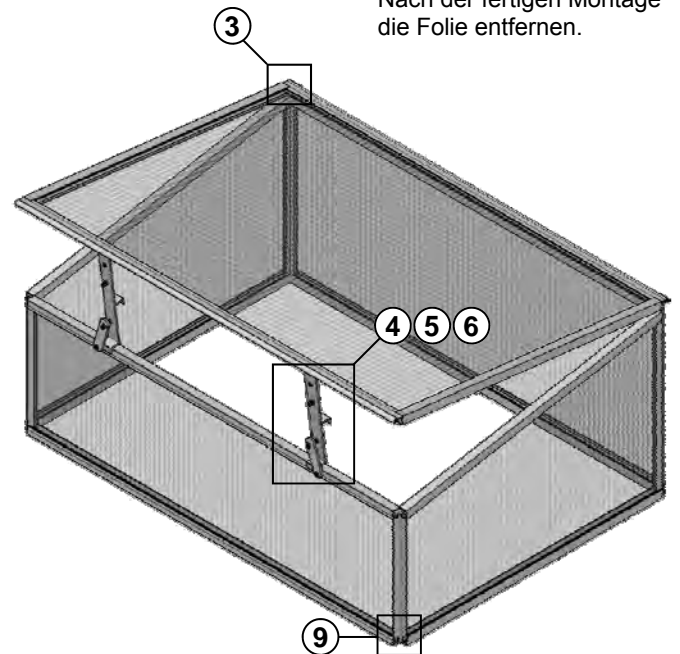
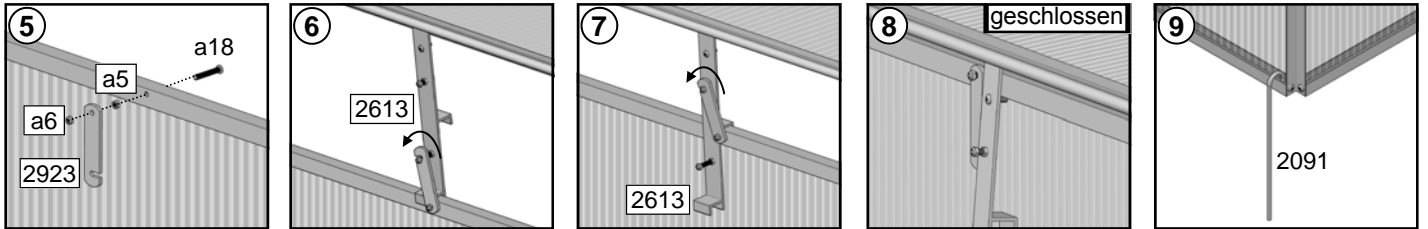

Stückliste:

Part No.	Length (mm)	Drawing	QTY
2903	752		2
2924	752		1
2910	752		1
2613	20		2
2091	230		4
2923	63		2
a16	Φ3.5x13		8
a18	M4x25		2
a5	M4		2
a6	M4-L		2
A1	751 x 230		1
C1	751 x 328		1
Side-L			1
Side-R			1
Vent			1

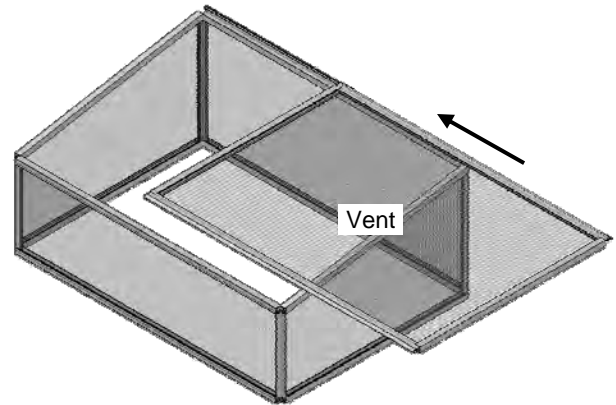
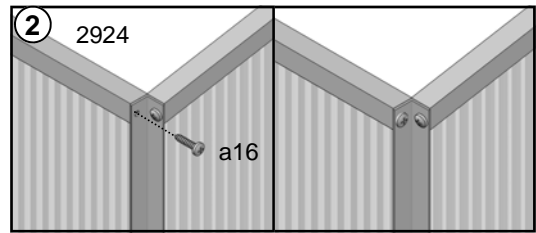
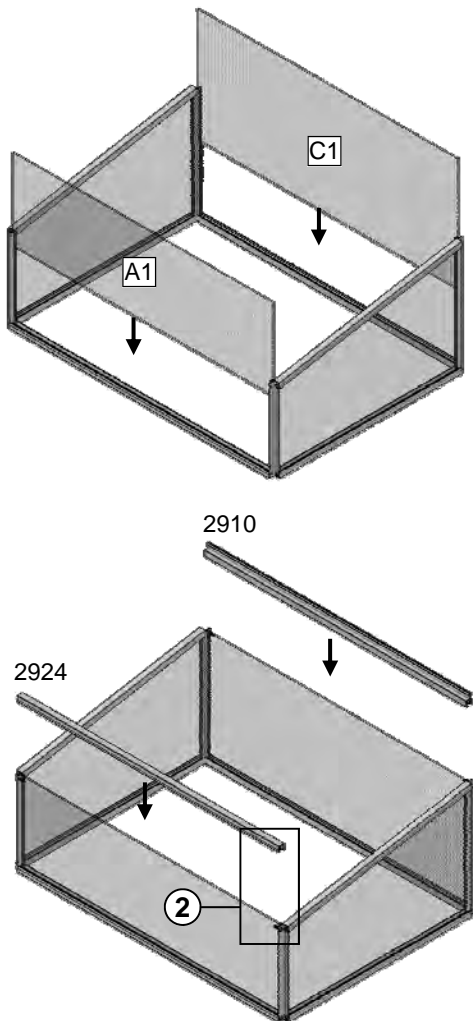
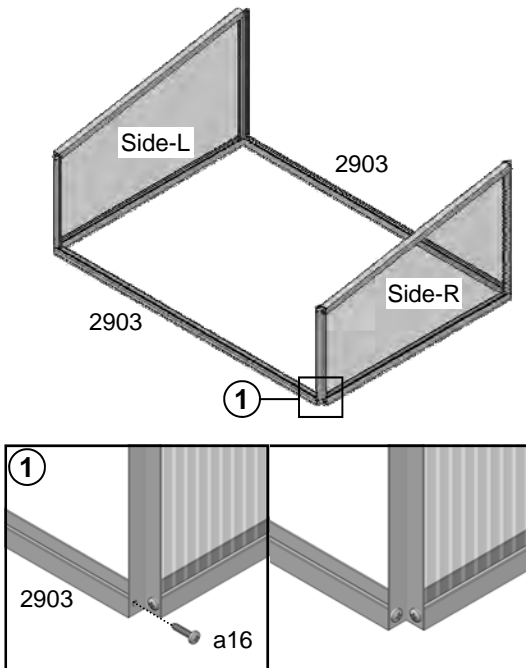



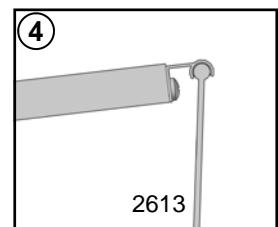
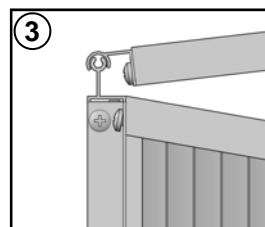
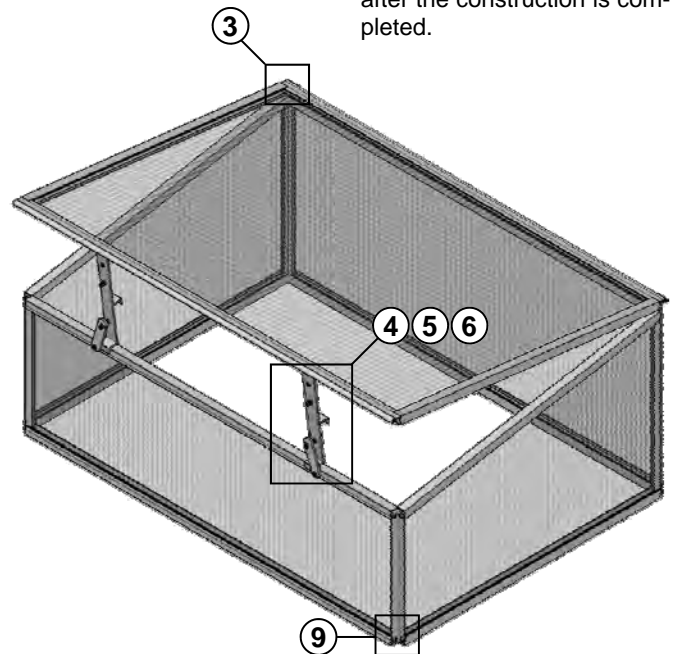

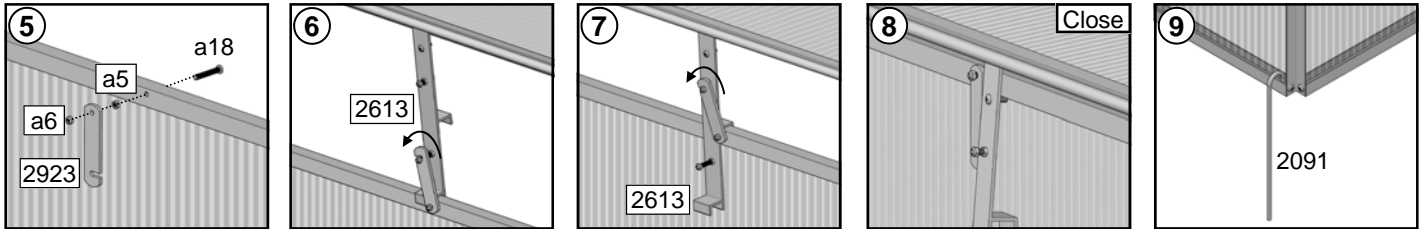







The polycarbonate side with text opal white film must face outward, remove all films after the construction is completed.



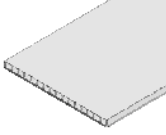

The list of Section

Part No.	Length (mm)	Drawing	QTY
2903	752		2
2924	752		1
2910	752		1
2613	20		2
2091	230		4
2923	63		2
a16	Φ3.5x13		8
a18	M4x25		2
a5	M4		2
a6	M4-L		2
A1	751 x 230		1
C1	751 x 328		1
Side-L			1
Side-R			1
Vent			1

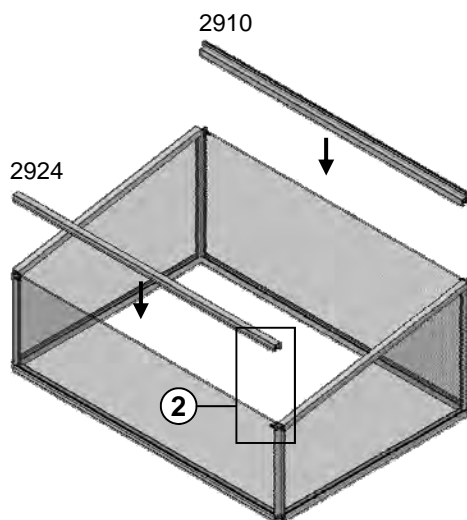
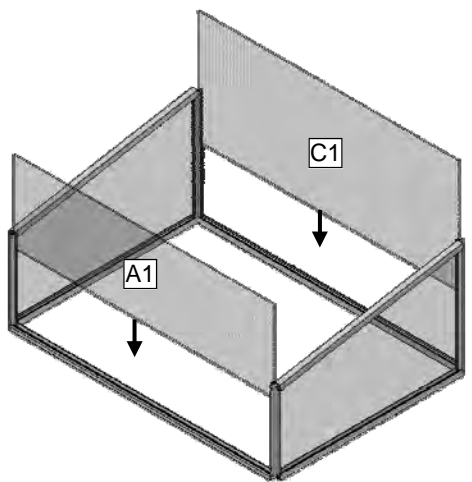
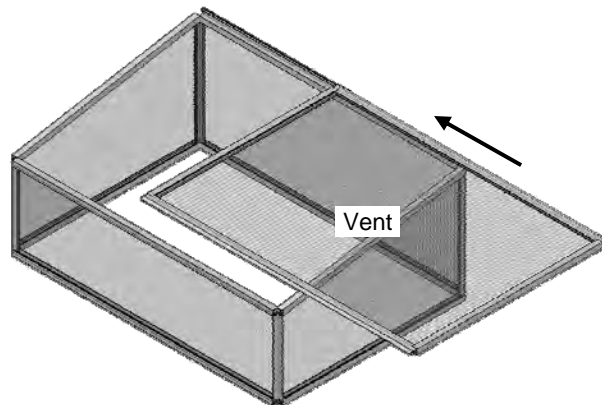
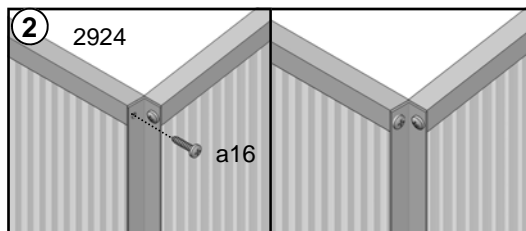
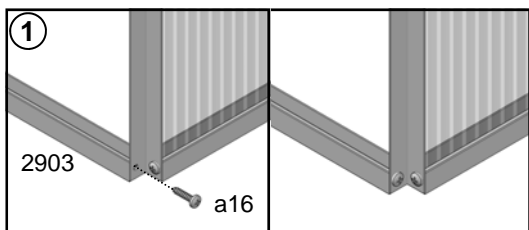
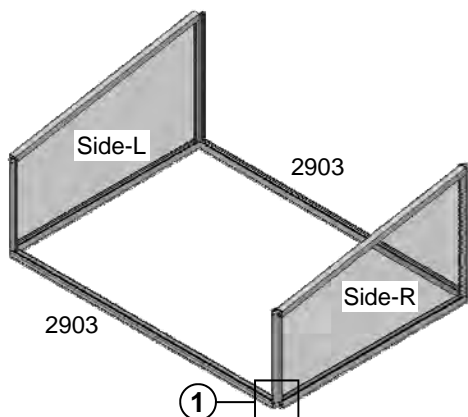



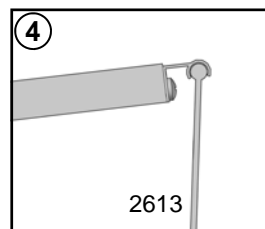
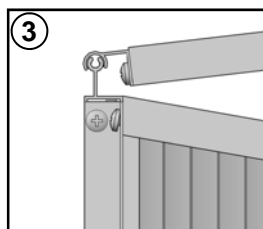
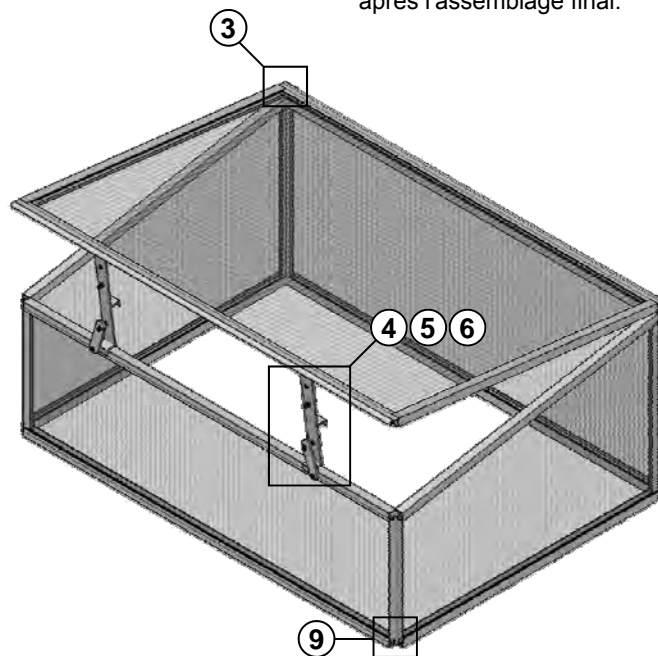

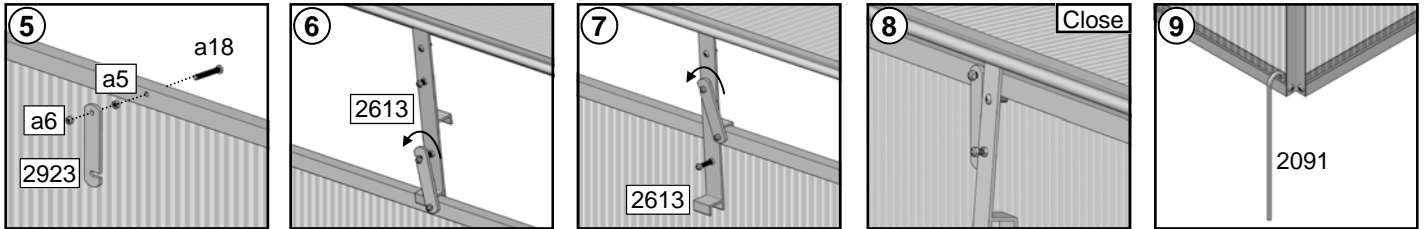







Installez le polycarbonate avec la feuille imprimé à l'extérieur. Retirez la feuille après l'assemblage final.



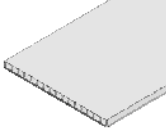

The list of Section

Part No.	Length (mm)	Drawing	QTY
2903	752		2
2924	752		1
2910	752		1
2613	20		2
2091	230		4
2923	63		2
a16	Φ3.5x13		8
a18	M4x25		2
a5	M4		2
a6	M4-L		2
A1	751 x 230		1
C1	751 x 328		1
Side-L			1
Side-R			1
Vent			1

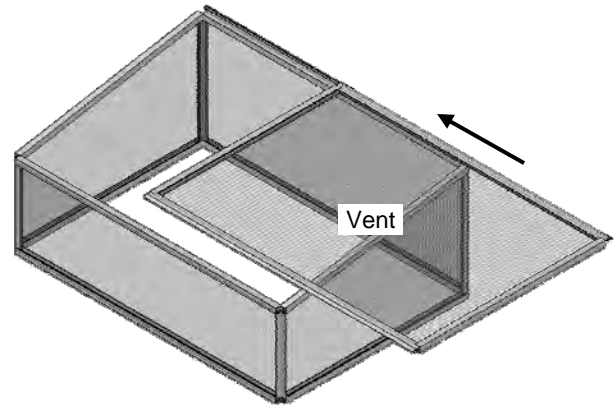
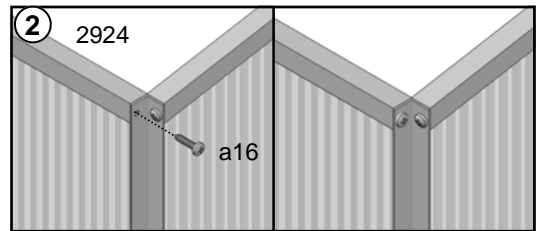
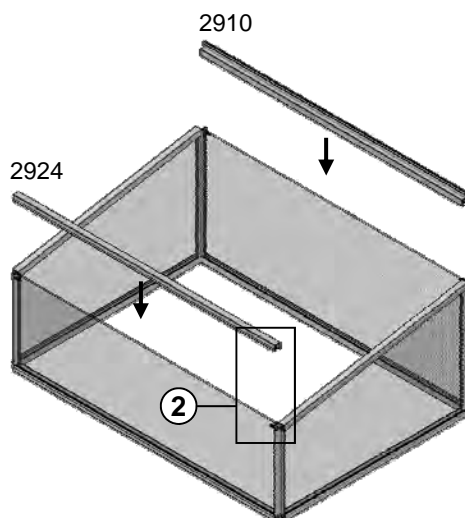
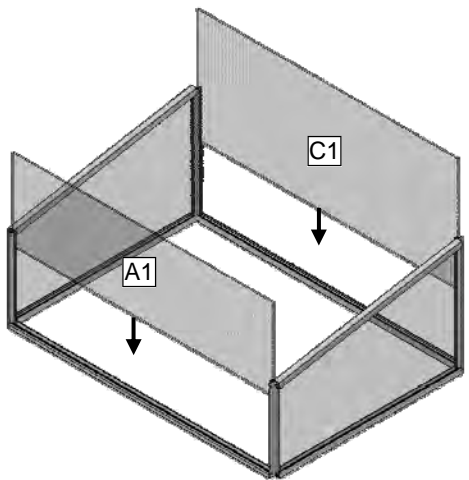
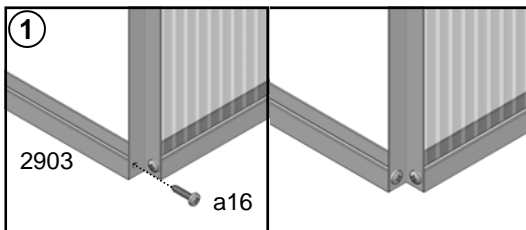
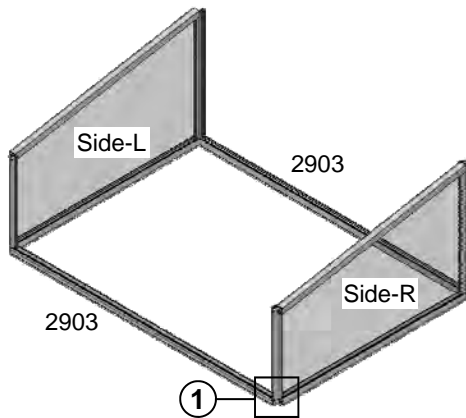



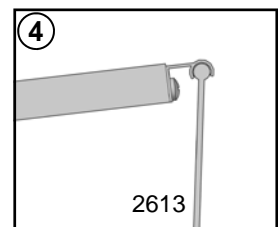
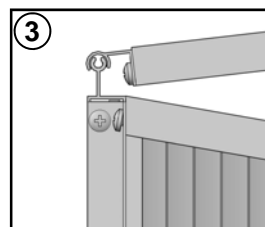
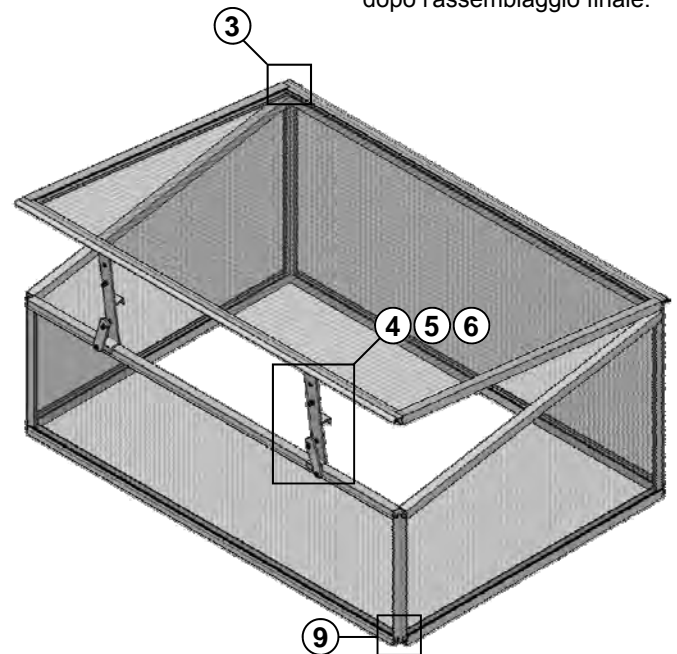

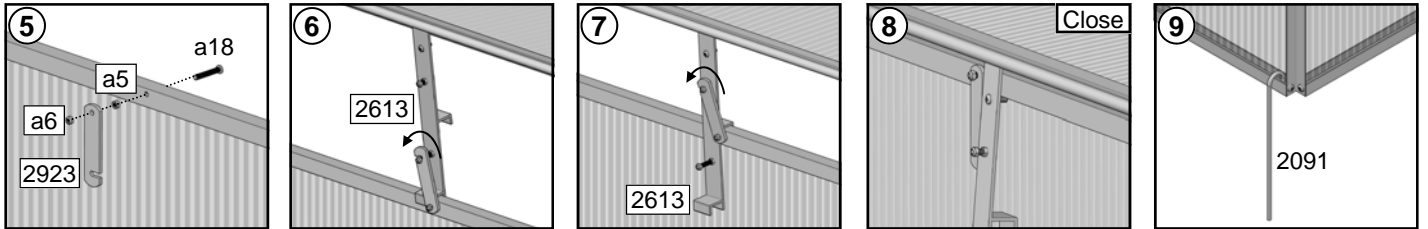







Installare il policarbonato con il foglio stampata all'esterno. Ritirare il foglio dopo l'assemblaggio finale.



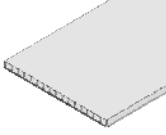

The list of Section

Part No.	Length (mm)	Drawing	QTY
2903	752		2
2924	752		1
2910	752		1
2613	20		2
2091	230		4
2923	63		2
a16	Φ3.5x13		8
a18	M4x25		2
a5	M4		2
a6	M4-L		2
A1	751 x 230		1
C1	751 x 328		1
Side-L			1
Side-R			1
Vent			1