

DE Aufbauanleitung für Geräteschrank Größe 150 und 230

- Ⓞ GB Assembly manual for equipment locker - size 150 and 230
- Ⓞ FR Instruction de montage pour l'armoire à outils - taille 150 et 230
- Ⓞ NL Opbouwbeschrijving voor de Tuinkast - grotte 150 en 230
- Ⓞ IT Istruzioni per il montaggio Armadio per attrezzi - misura 150 e 230
- Ⓞ ES Instrucciones de montaje del armario de jardín - tamaño 150 y 230

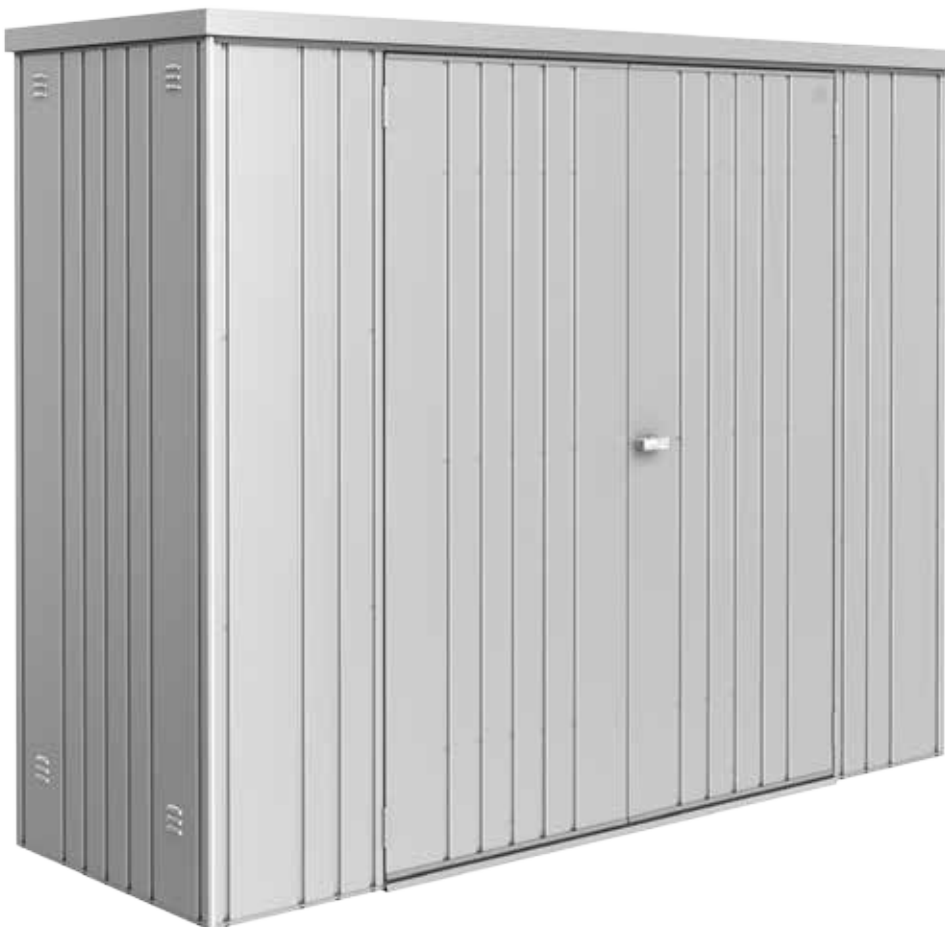

Wichtige Punkte für den Aufbau!

Vorliegende Aufbauanleitung zeigt den Zusammenbau von „Geräteschrank“ Größe „230“; sie gilt sinngemäß auch für die Größe „150“. Für einige Montageschritte benötigen Sie einen Helfer.

- GB** *Important details regarding assembly! This assembly manual shows the erection of the garden shed model "Geräteschrank" size "230"; it is also valid for size "150" For several assembly steps additional assistance of one person will be required.*
- FR** *Points importants lors du montage! " Cette notice de montage décrit l'assemblage de l'abri „Geräteschrank“ taille « 230 »; celle-ci est aussi valable pour la taille « 150 ». Pour certaines étapes, demandez l'aide d'une personne.*
- NL** *Deze montage instructies hebben betrekking op de opbouw van de Geräteschrank , grootte 230. De instructies zijn ook van toepassing op de grootte 150. Voor enkele montage stappen heeft u 1 persoon nodig om u te helpen.*
- ES** *Notas importantes para el montaje: Estas instrucciones muestran el montaje de la caseta "Geräteschrank" en tamaño 230. También son válidas para el tamaño 150. Es recomendable realizar el montaje con una otra persona.*
- IT** *Indicazioni importanti per il montaggio! Le seguenti istruzioni di montaggio fanno riferimento all'assemblaggio di „Geräteschrank“ misura „230“; per analogia sono valide anche per la misura „150“. Per alcune fasi di assemblaggio vi serviranno 1 aiutante.*

Um Kratzer zu vermeiden, verwenden Sie bitte geeignete Unterlagen!

- GB** *Please use a suitable underlay to avoid scratches!*
- FR** *Pour éviter les rayures, utilisez les supports appropriés!*
- NL** *Om krassen te voorkomen raden wij u aan er iets onder te leggen!*
- ES** *Por favor, coloque en el suelo una base protectora adecuada para evitar posibles arañazos.*
- IT** *Utilizzare una base adatta per evitare graffi!*

Schraubverbindungen grundsätzlich erst am Ende der Montage festziehen!

- GB** *Nuts not to be tightened before the end of assembly!*
- FR** *Ne serrer les écrous à fond qu'à la fin du montage!*
- NL** *Schroeven pas aan het einde van de montage vastdraaien!*
- ES** *En principio, no apriete fijamente las tuercas hasta que no haya terminado de montar la caseta.*
- IT** *I dadi devono essere serrati a fondo soltanto alla fine del montaggio!*

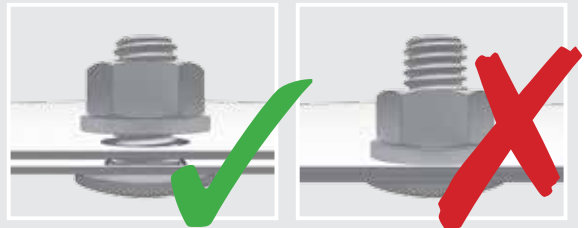

Nicht bei Wind aufbauen!

- GB** *Do not assemble the shed on a windy day!*
- FR** *Ne pas assembler quand il y a du vent !*
- NL** *Niet bij wind opbouwen!*
- ES** *No monte la caseta si hace mucho viento.*
- IT** *Non montare la casetta in giornate di vento!*



Verwenden Sie bei der Montage Arbeitshandschuhe!

- GB** *Wear working gloves!*
- FR** *Portez des gants de travail*
- NL** *Handschoenen gebruiken!*
- ES** *Utilice unos guantes de trabajo.*
- IT** *Utilizzare guanti da lavoro*





Optionales Zubehör - Symbol:

Arbeitsschritte die blau eingerahmt sind, zeigen den Einbau eines optionalen Zubehörteiles.

- (GB) *Symbol of optional accessories: Blue framed assembly steps show the installation of optional accessories.*
- (FR) *Accessoires en option-Symbole: La trame entourée en bleu indique une étape avec accessoires en option. A réaliser uniquement si vous avez commandé cet accessoire.*
- (NL) *Extra Toebehoor: Montageschappen met een blauwe rand betreffen de inbouw van extra toebehoor.*
- (ES) *Accesorio opcional - símbolo: Los pasos de montaje que se encuentran enmarcados en azul muestran el montaje de una pieza de un accesorio opcional.*
- (IT) *Simbolo per accessori opzionali: Le fasi del montaggio incorniciate in colore azzurro mostrano l'installazione di un accessorio opzionale.*



optionales Zubehör - Accesso...

Bodenrahmen

(Floor Frame - Cad)



Wasserwaagen - Symbol:

Betreffendes Einbauteil mit der Wasserwaage ausrichten.

- (GB) *Symbol of spirit level: Align the respective parts by using the spirit level.*
- (FR) *Symbole niveau à bulle: Lorsque ce symbole apparaît, vous devez ajuster l'élément à l'aide d'un niveau à bulle.*
- (NL) *Waterpas - symbol: Bij montageschappen waar dit symbool bijstaat is het noodzakelijk het betreffende onderdeel waterpas in te bouwen.*
- (ES) *Símbolo del nivelador: Indica que se debe ajustar y centrar la pieza con la ayuda de un nivelador.*
- (IT) *Simbolo di livella a bolla d'aria: Allineare il componente in questione con l'ausilio di una livella a bolla d'aria.*

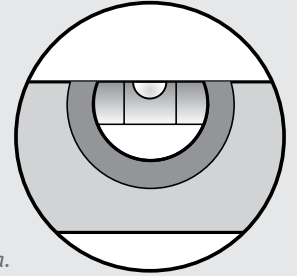

Größenabhängiger Montageschritt!

- (GB) *Size-Dependent assembly step!*
- (FR) *Dépendant de la taille assemblage étape!*
- (NL) *Size-Dependent montagestap!*
- (ES) *Paso de montaje de tamaño Dependiente!*
- (IT) *Taglia-Dependent fase di montaggio!*



Größenabhängiger Montageschritt

Nur für Größe 150

(Only for size 150 - Uniquement

Maßstabsgetreue Abbildungen der zu verwendenden Schrauben:

- (GB) *Scale drawing 1:1 of the screws in use*
- (FR) *Reproduction selon l'échelle 1:1.*
- (NL) *Afbeelding : schaal 1:1 (ware grootte)*
- (ES) *Reproducción a escala 1:1 de los tornillos que se utilizan para el montaje.*
- (IT) *Immagine in scala delle viti da utilizzare!*

M 1:1

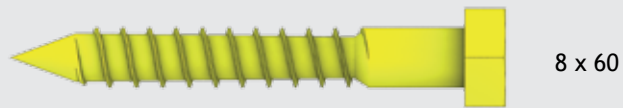

8 x 60

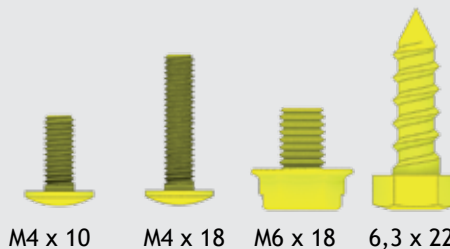

M4 x 10

M4 x 18

M6 x 18

6,3 x 22

Pflege und Wartung

- Keine aggressiven Chemikalien wie z.B. Chlor oder Streusalz offen lagern!
- Sonnenmilch und andere Cremes mit Wasser und Seife entfernen
- Keine scheuernden Reinigungsmittel verwenden!
- Tiefe Kratzer sofort mit beiliegendem Lack ausbessern!
- Ölen Sie das Schloss jährlich!

EN Care and maintenance

- Do not store aggressive substances uncovered i.e. chlorine or road salt
- Remove suntan lotion or any other creams with water and rinse aid!
- Do not use abrasive cleaning agents!
- Touch-up scratches immediately with the paint provided.
- Lubricate the lock once a year!

FR Entretien et maintenance

- Ne pas stocker de produits chimiques (chlore, sel, etc...)
- Nettoyez uniquement avec de l'eau les crèmes solaires et autres crèmes (pas de nettoyeur chimique).
- Corrigez immédiatement les rayures avec la laque jointe!
- Graissez la serrure et les charnières chaque année !

NL Onderhoud

- Geen chemicaliën om de berging opslaan
- Zonnebrandolie/melk en andere cremes met water en glansmiddel verwijderen
- Gebruik geen schuurmiddelen!
- Krassen direct met de meegeleverde lak behandelen
- Slot jaarlijks oliën

ES Cuidado y mantenimiento

- No almacene productos químicos agresivos dentro de la caseta como por ejemplo cloro y sal antiescarcha.
- Evite dejar huellas o restos de cremas solares sobre la chapa. Limpie la caseta siempre con agua o un trapo húmedo.
- Repare los arañazos lo antes posible con el barniz que se incluye
- Aplique aceite en la cerradura y las bisagras una vez al año

IT Manutenzione

- Non lasciare prodotti chimici aggressivi (come ad esempio cloro o sale per strade) all'interno della casetta!
- Rimuovere crema solare e altre creme con acqua e brillantante!
- Ritoccare immediatamente eventuali graffi con la vernice fornita nella confezione!
- Lubrificare la serratura e le cerniere a cadenza annuale!

Vorschläge für das Fundament

Bitte achten Sie bei der Fundamentgestaltung darauf, dass Niederschlagswasser nicht seitlich unter den Bodenprofilen in das Gerätehaus eindringen kann! (siehe Varianten 1, 2, 3). Aufsteigende Bodenfeuchtigkeit und Kondensation vermeiden Sie mittels einer starken Kunststoffolie unter dem Fundament.

GB *Proposals for a secure foundation*

When making the foundation arrangements please take necessary precaution to ensure that water cannot leak in under the floor profiles (see option 1, 2, 3). Rising ground moisture and condensation can be avoided by using a strong plastic sheet underneath the paving slabs or underneath the concrete foundation.

FR *Conseils pour les fondations*

Lors de la réalisation de la fondation, veillez à ce que l'eau de pluie ne puisse pas pénétrer dans l'abri ou par les côtés sous les profils de sol (voir variantes 1,2,3). Vous pouvez éviter l'humidité du sol et la condensation en mettant un film plastique épais sous les plaques de béton.

NL *Voorstellen voor fundament*

Let er bij het maken van de fundering op dat regenwater niet onder het bodemprofiel kan doorlopen (zie voorbeeld 1,2,3). Een vochtige bodem en condensatie kunt u vermijden door het aanbrengen van een sterke kunststoffolie onder de tegels of het betonfundament.

ES *Medidas y recomendaciones para los cimientos:*

Al colocar los cimientos, asegúrese de que el agua de lluvia no puede penetrar en la caseta por los laterales debajo del perfil del suelo (véase variante 1,2 y 3). Evite la humedad y la condensación en el suelo colocando una lámina de plástico bajo las losas o los cimientos de hormigón.

IT *Proposte per il basamento:*

Il basamento deve essere progettato in modo da evitare infiltrazioni di acqua piovana all'interno della casetta (vedere proposta 1-2-3). Un telo di plastica spesso posto in corrispondenza dell'area di pavimento evita infiltrazioni di umidità dal terreno e la formazione di condensa.



Weitere Details betreffend Fundament finden Sie auch unter www.biohort.com/Fundament

Further details about foundations you will find on www.biohort.com/foundation

Pour détails supplémentaires veuillez consulter www.biohort.com/fondations

Verdere details over het fundament vindt u ook op www.biohort.com/fundament

Maße für das Fundament

(GB) Foundation dimensions

(ES) Medidas de los cimientos

(FR) Dimensions pour la fondation

(IT) Dimensioni del basamento

(NL) Maat voor het fundament

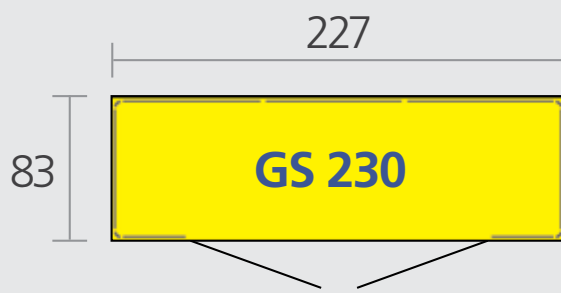
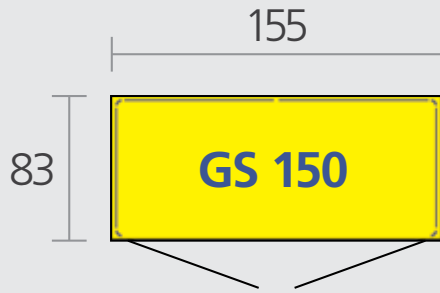

ACHTUNG ATTENTION
ATTENTION | ATTENTIE |
LET OP | ATENCIÓN |
ATTENZIONE



Die Verankerung ist wichtig, denken Sie an Sturmböen!

Do not forget to anchor the shed against gale force wind!

L'ancrage est important, pensez aux rafales de vent!

Verankering niet vergeten!

El anclaje es muy importante. Piense por ejemplo en rachas fuertes de viento.

L'ancoraggio della casetta è importante - pericolo in caso di raffiche di vento!

Variante, Proposal, Variant 1

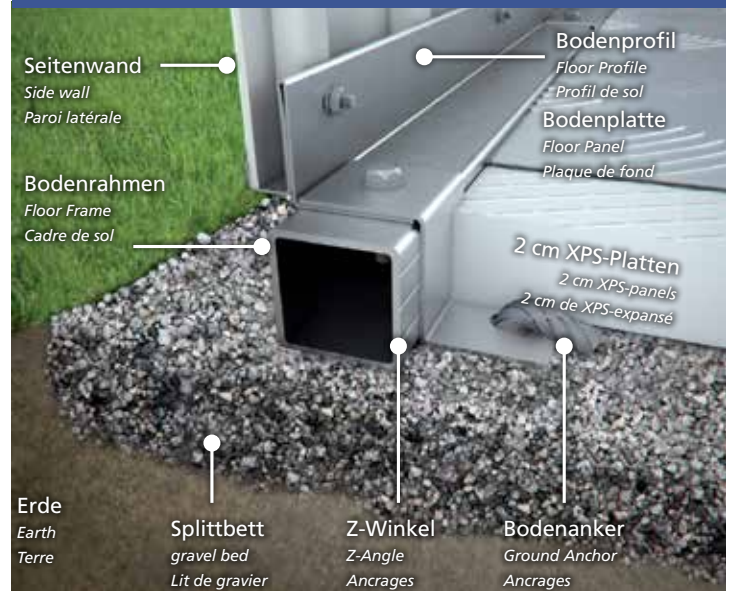

Variante, Proposal, Variant 2

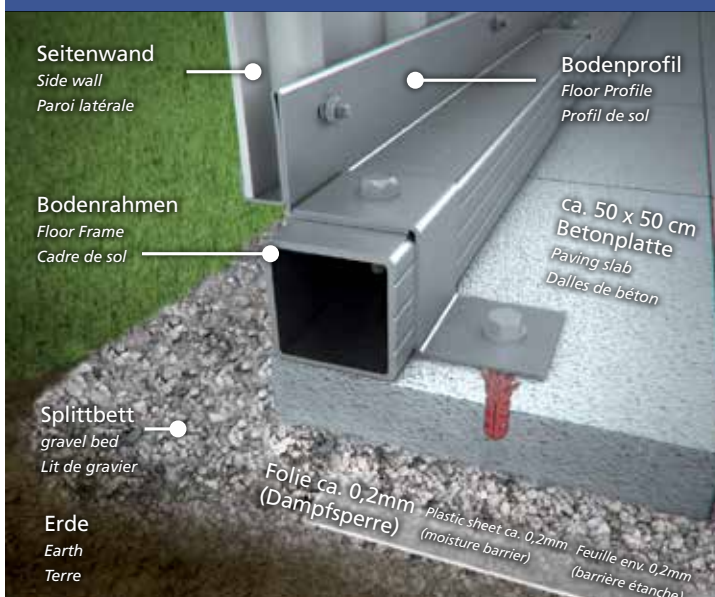

Variante, Proposal, Variant 3

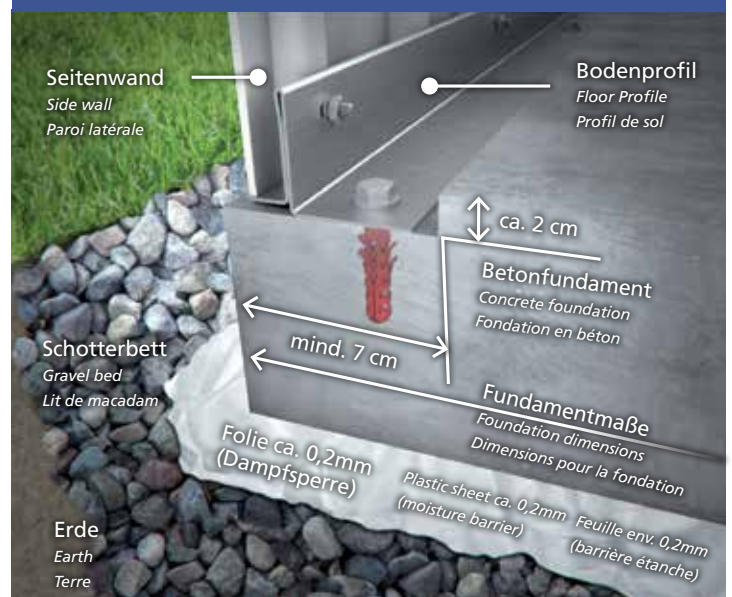



Paket Nr. 1

Dach-Profilpaket · top profile package · carton de profils de toit · dakprofielpakket · pacco profili del tetto · kit de perfiles de tejado · de la puerta y del corpus

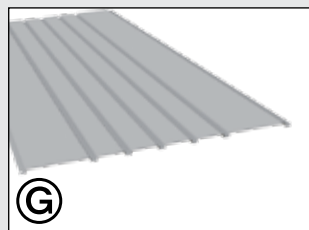
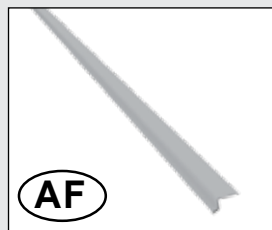
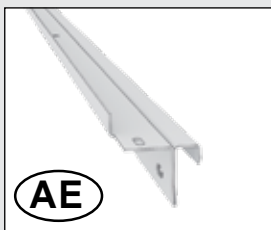

Nur für Größe 230
 (Only for size 230
 Uniquement pour taille 230
 Alleen voor maat 230
 sólo para los tamaños 230
 solo per misura 230)

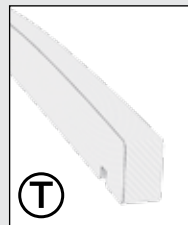
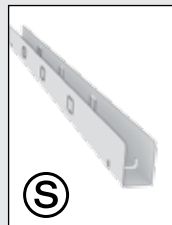
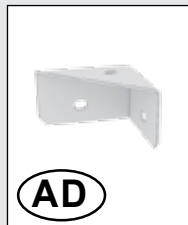
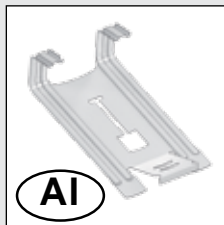
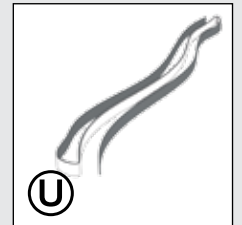
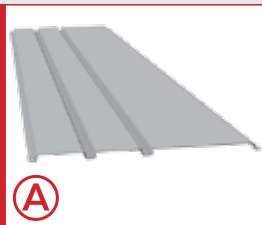

Paket Nr. 2

Korpus-Türpaket · corpus-door package · carton de l'ossature · et la porte · deur-corpus pakket · pacchetto di corpus e porta · paquete de la puerta y del corpus

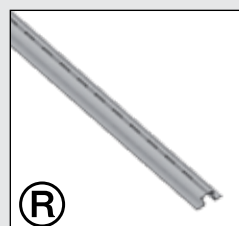
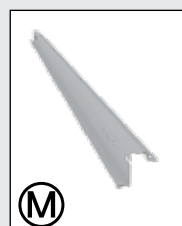
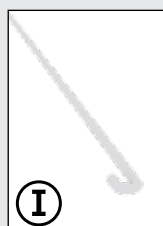
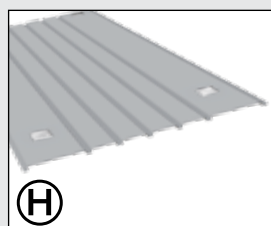
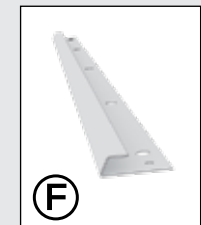
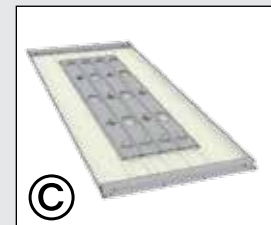
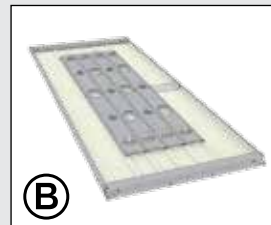
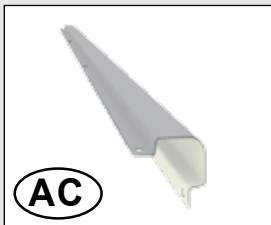



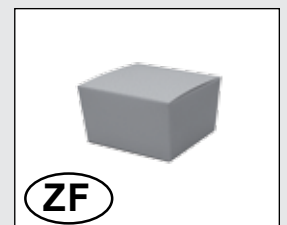
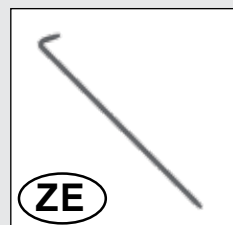
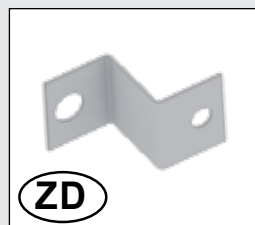

Bodenrahmen

Floor Frame · Cadre de sol · Telaio perimetrale · Bodemframe · marco de suelo



1.

 Ⓛ	 GS 150: 2x (770mm) GS 230: 2x (770mm)	 Ⓛ	 GS 150: 2x (1490mm) GS 230: 2x (2210mm)	M4 x 10  ⓁD2	GS 150: 4x GS 230: 4x
--	---	--	---	---	--------------------------

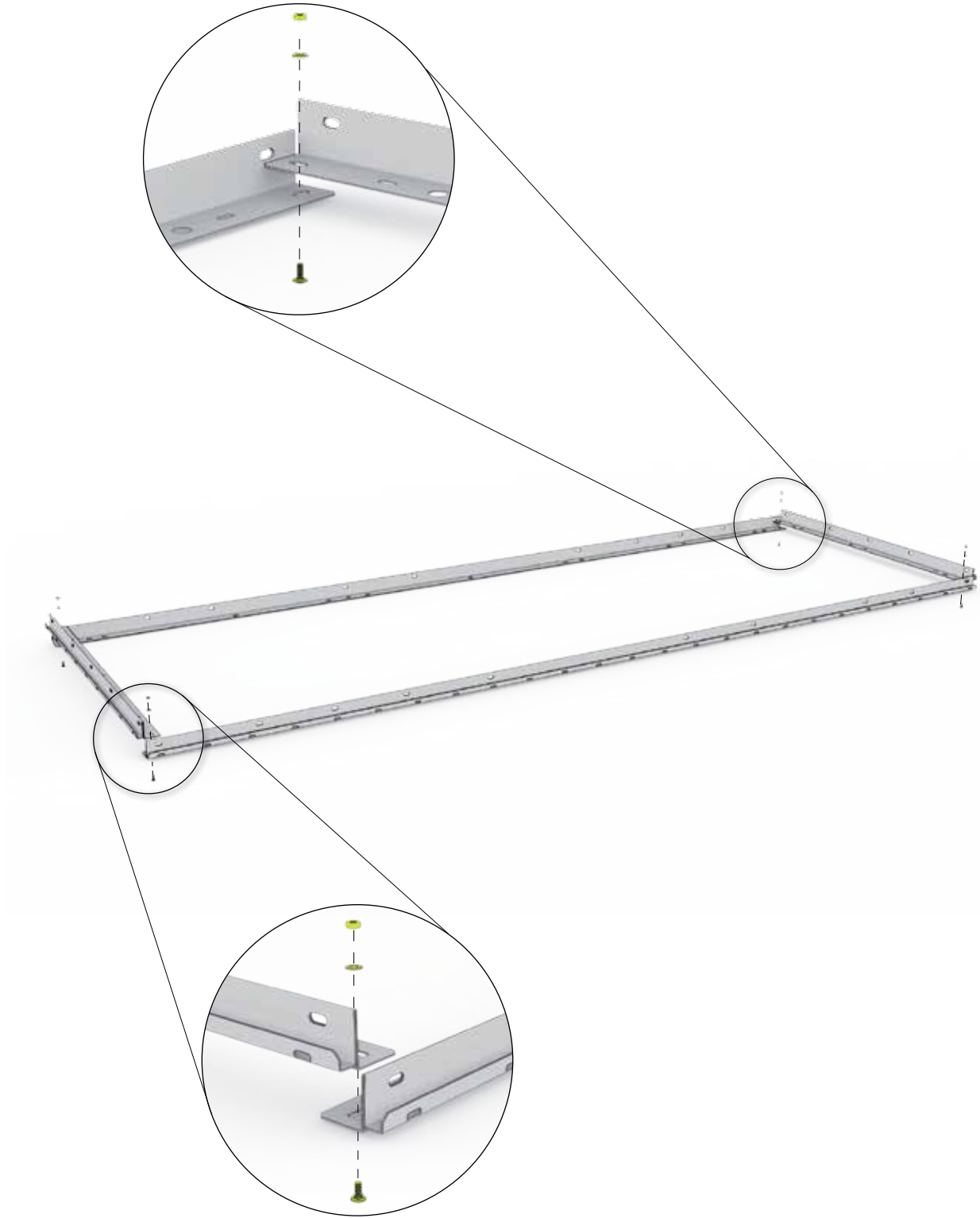

2.

2



GS 150: 1x (1380mm)
GS 230: 1x (1380mm)

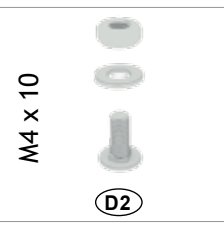

GS 150: 2x
GS 230: 2x

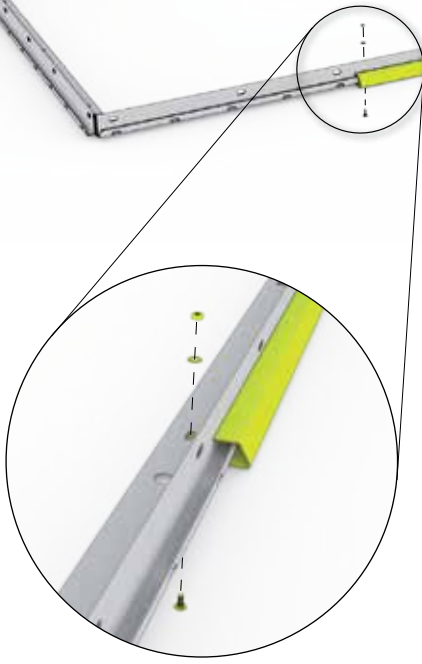
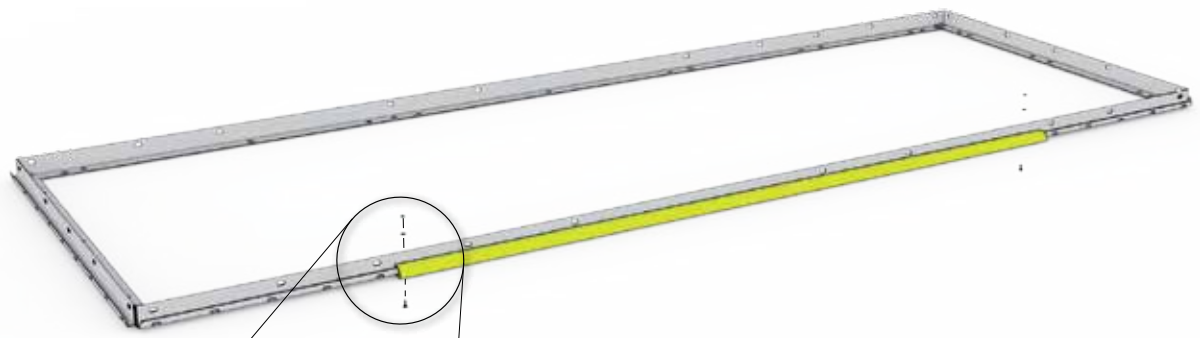

3.

2

GS 150: 1x

GS 230: 1x

Ⓜ

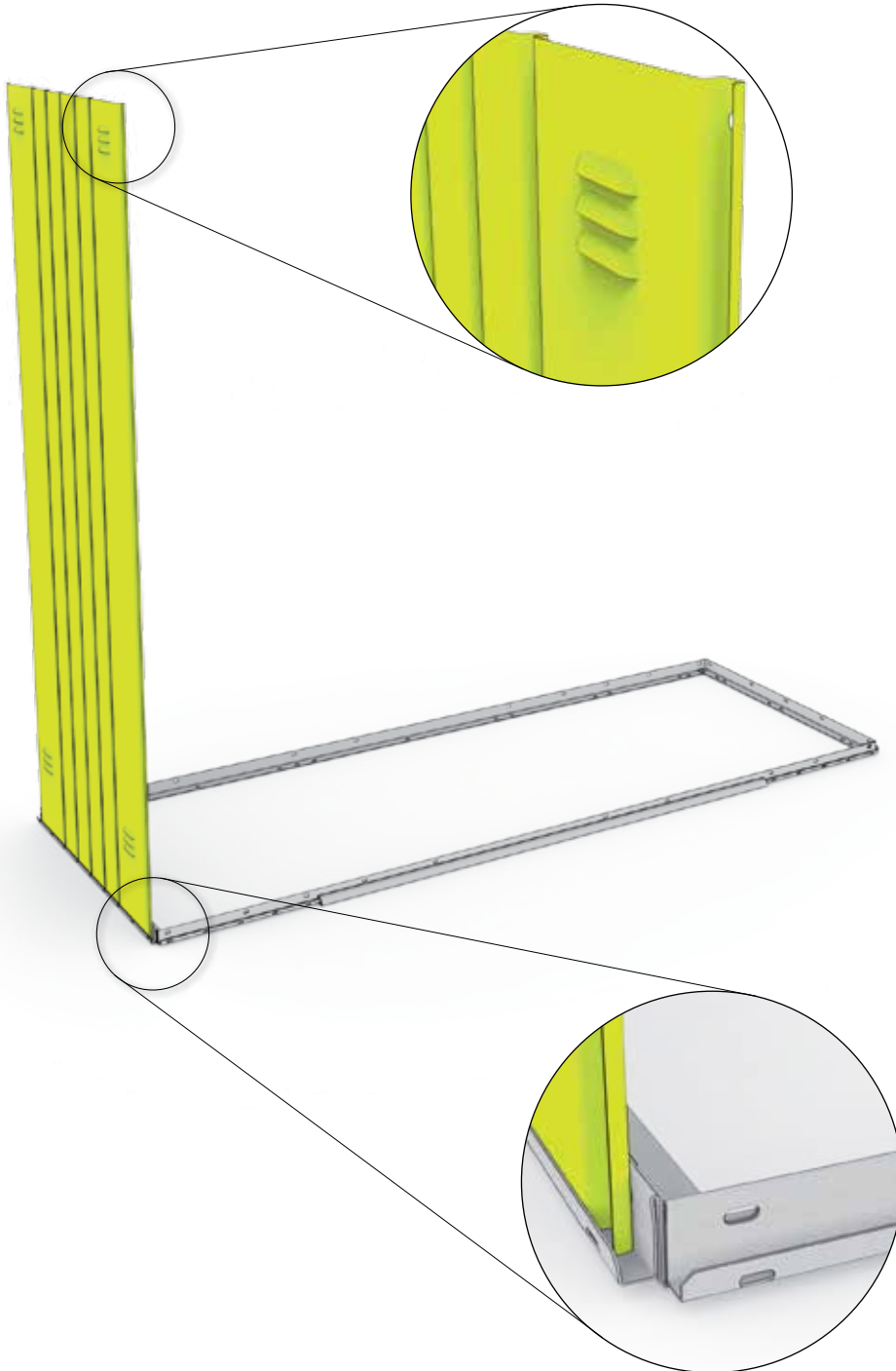

4.

2

AC

GS 150: 2x
GS 230: 2x

M4 x 10

D2

GS 150: 6x
GS 230: 6x

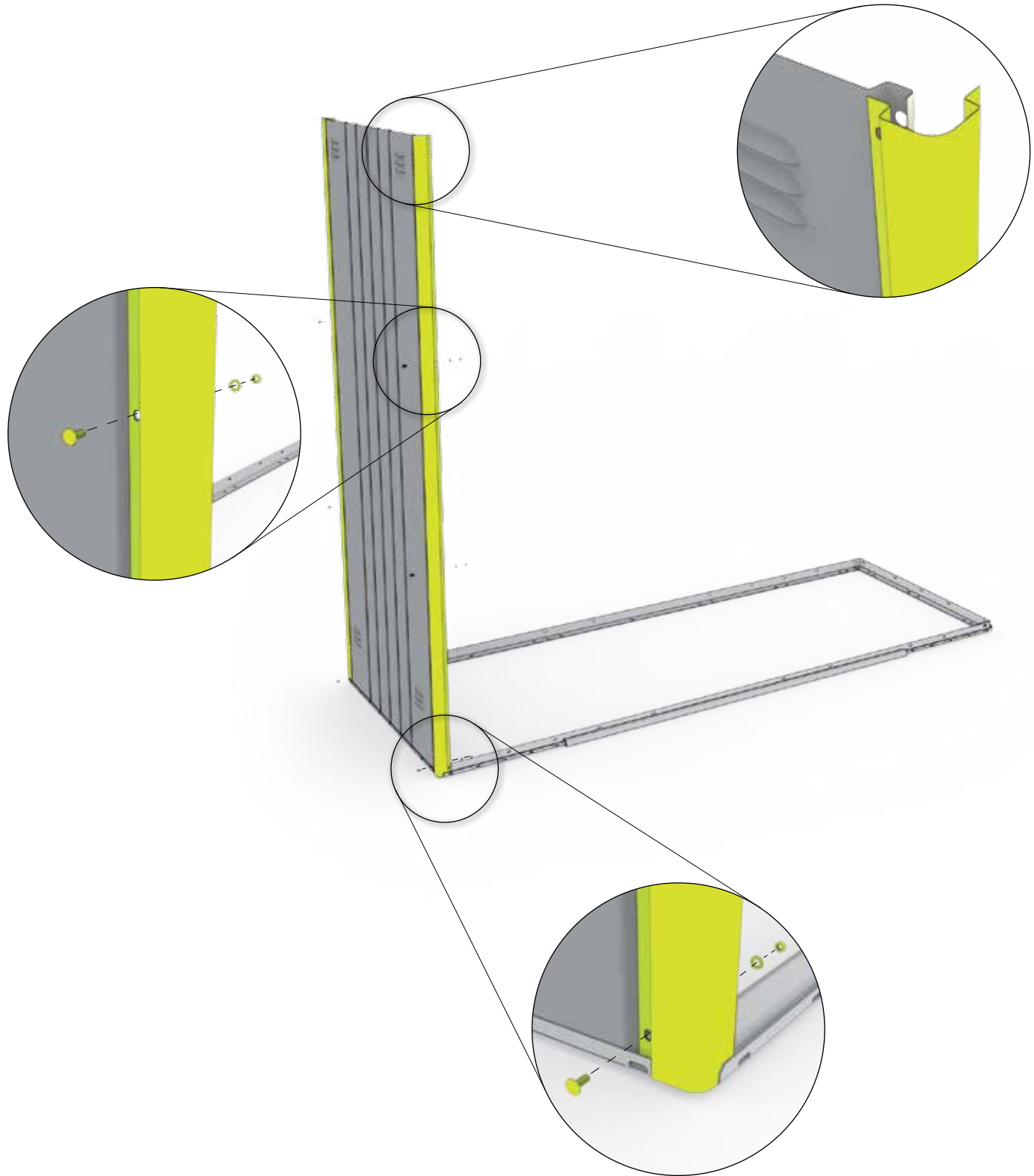

5.

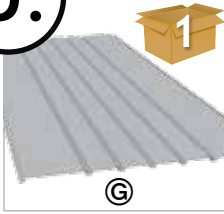

GS 150: 2x
GS 230: 3x

M4 x 10
D2

GS 150: 6x
GS 230: 9x

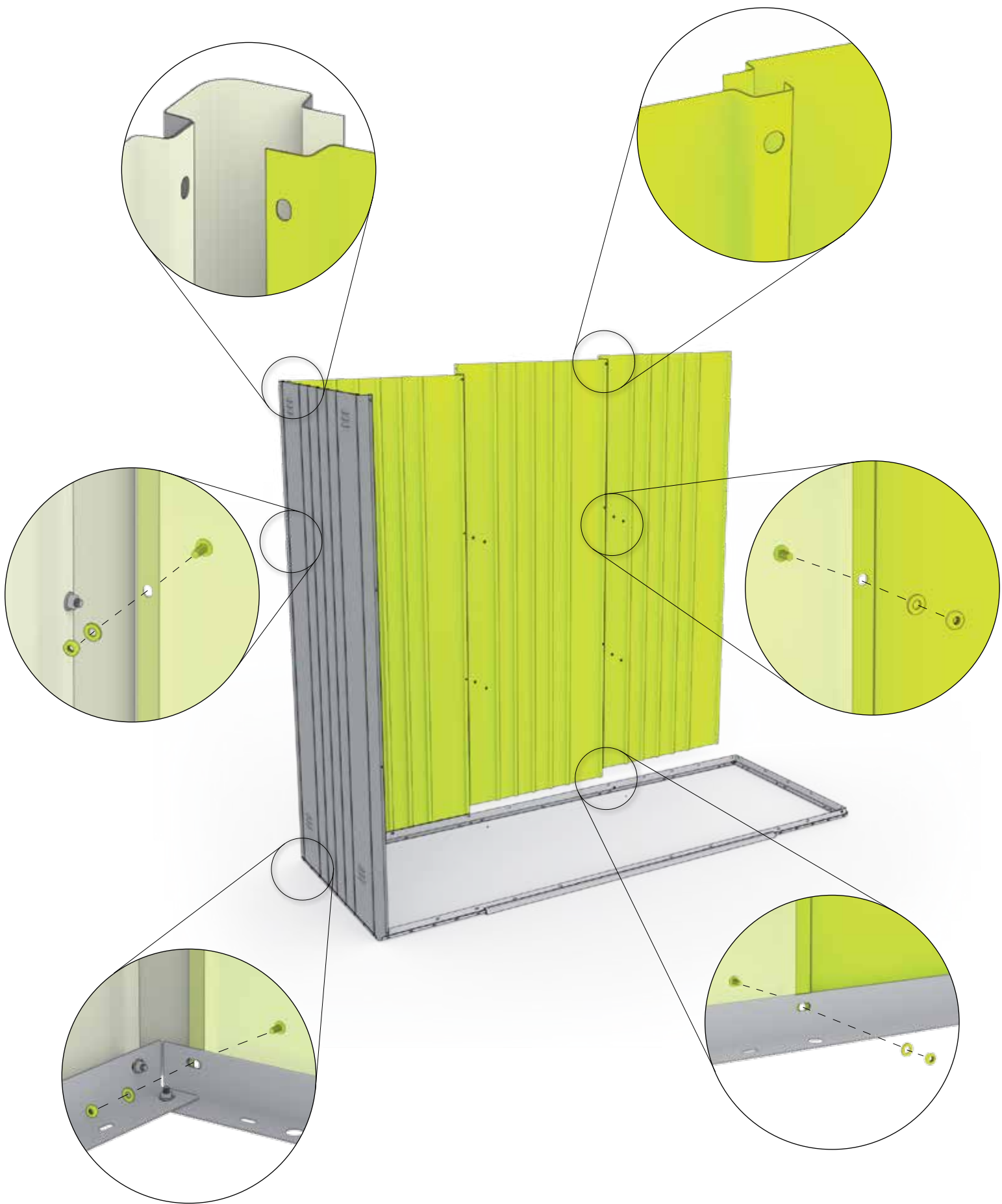

6.

2

AC

GS 150: 1x
GS 230: 1x



M4 x 10

D2

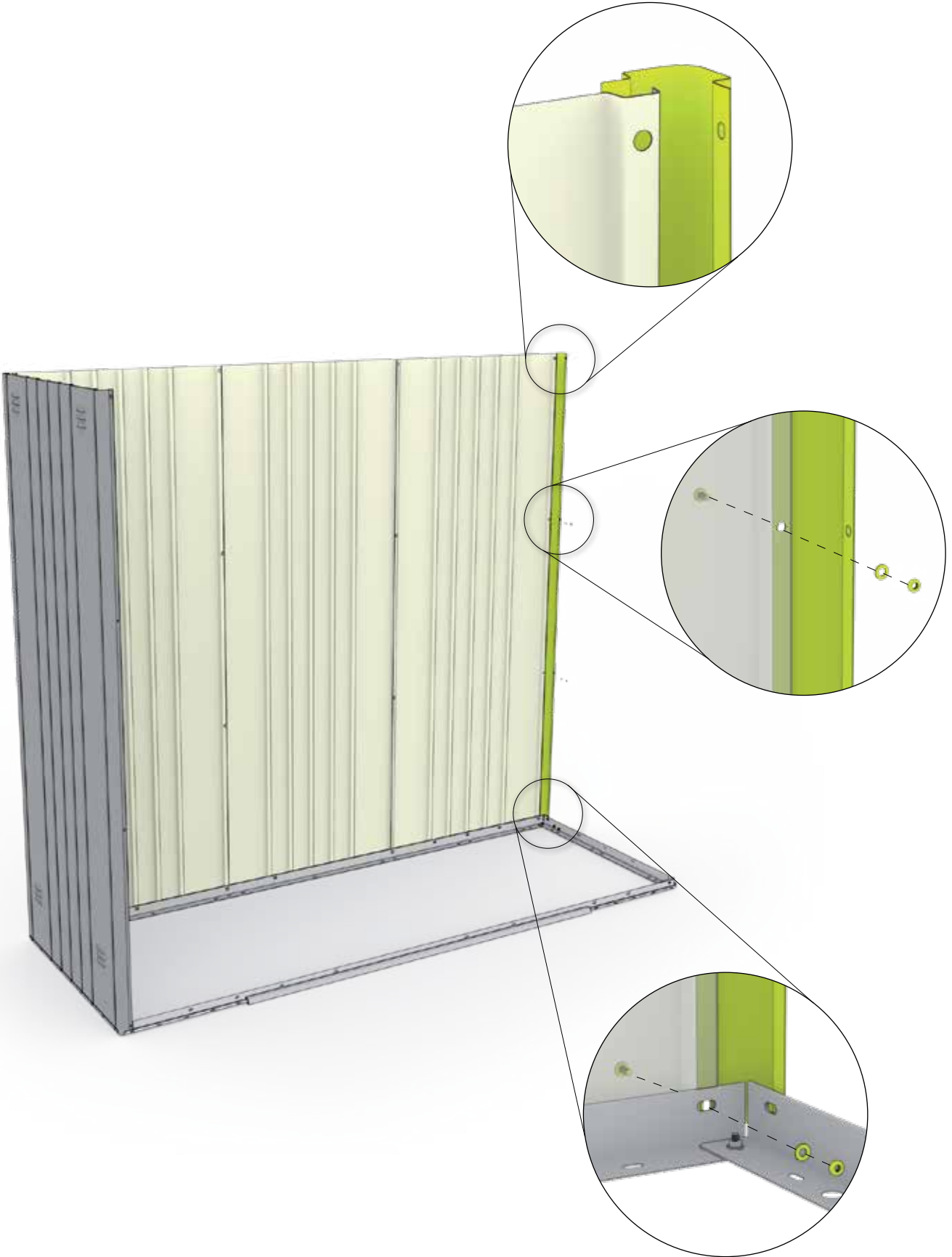
GS 150: 3x
GS 230: 3x

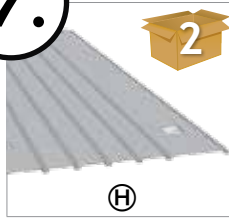

7.

	 GS 150: 1x GS 230: 1x	M4 x 10  D2	GS 150: 3x GS 230: 3x
---	---	--	--------------------------

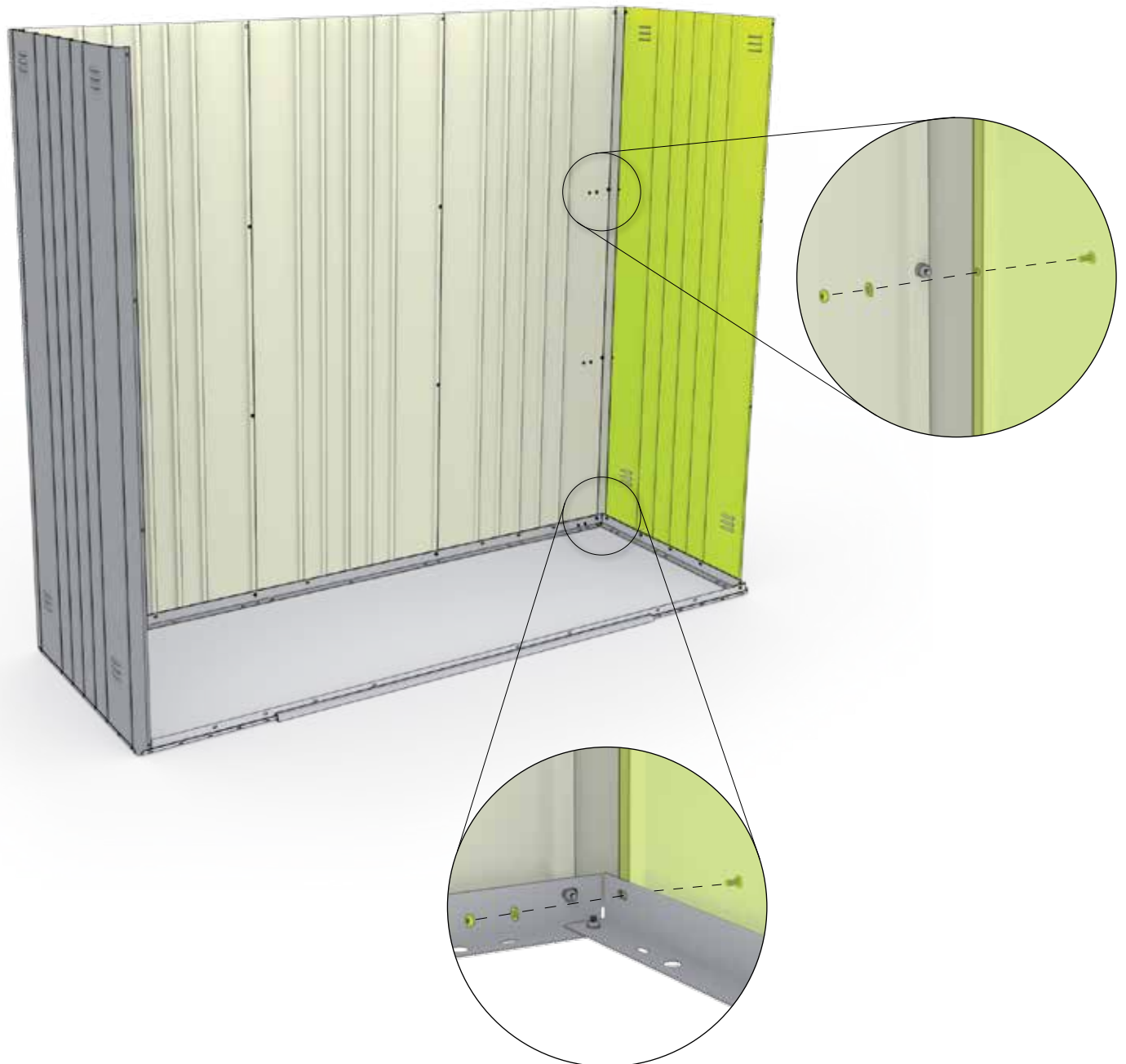

8.

2

AC

GS 150: 1x
GS 230: 1x



M4 x 10

D2

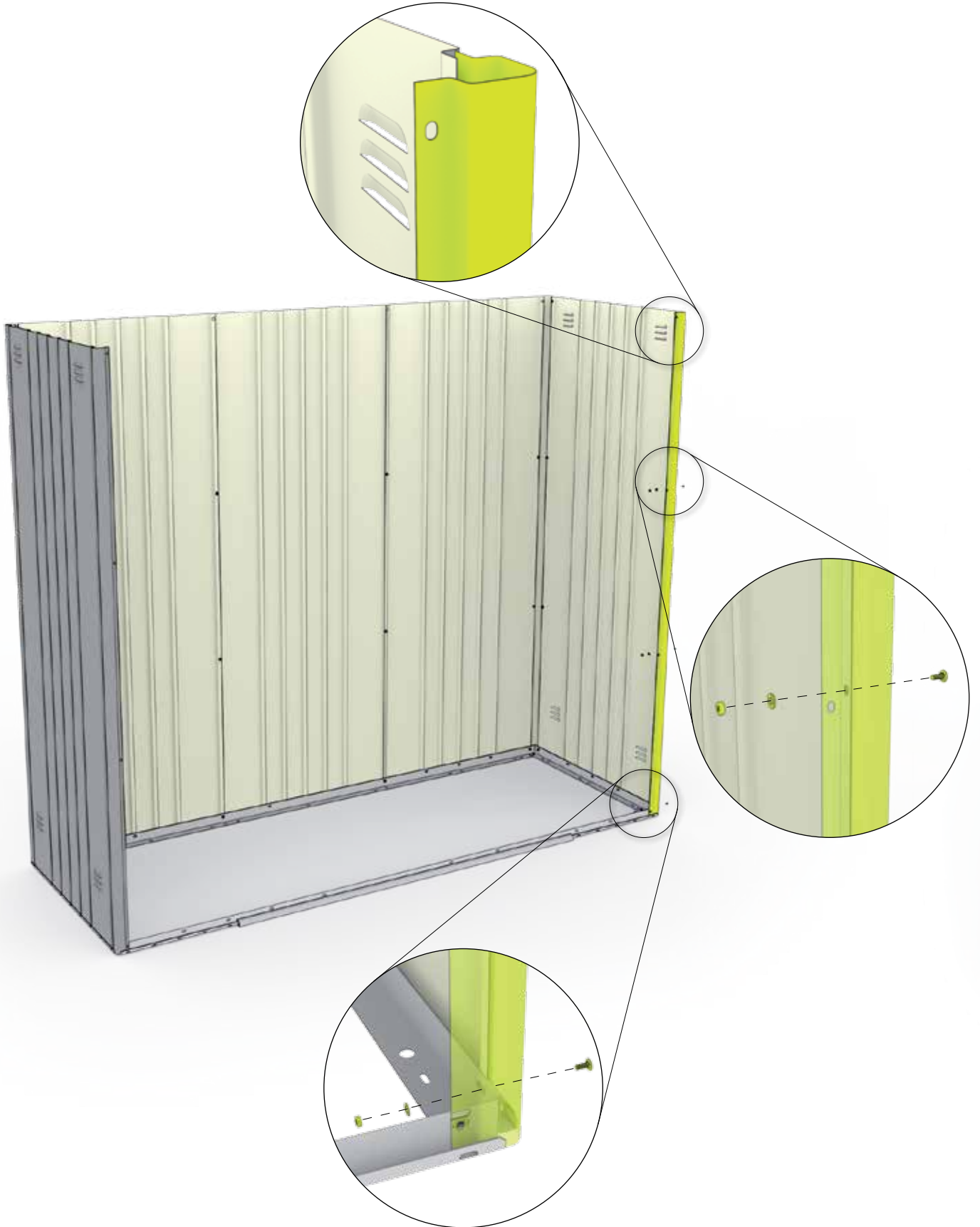
GS 150: 3x
GS 230: 3x



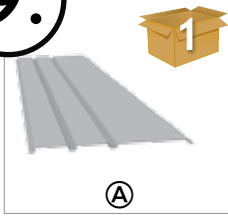

9.

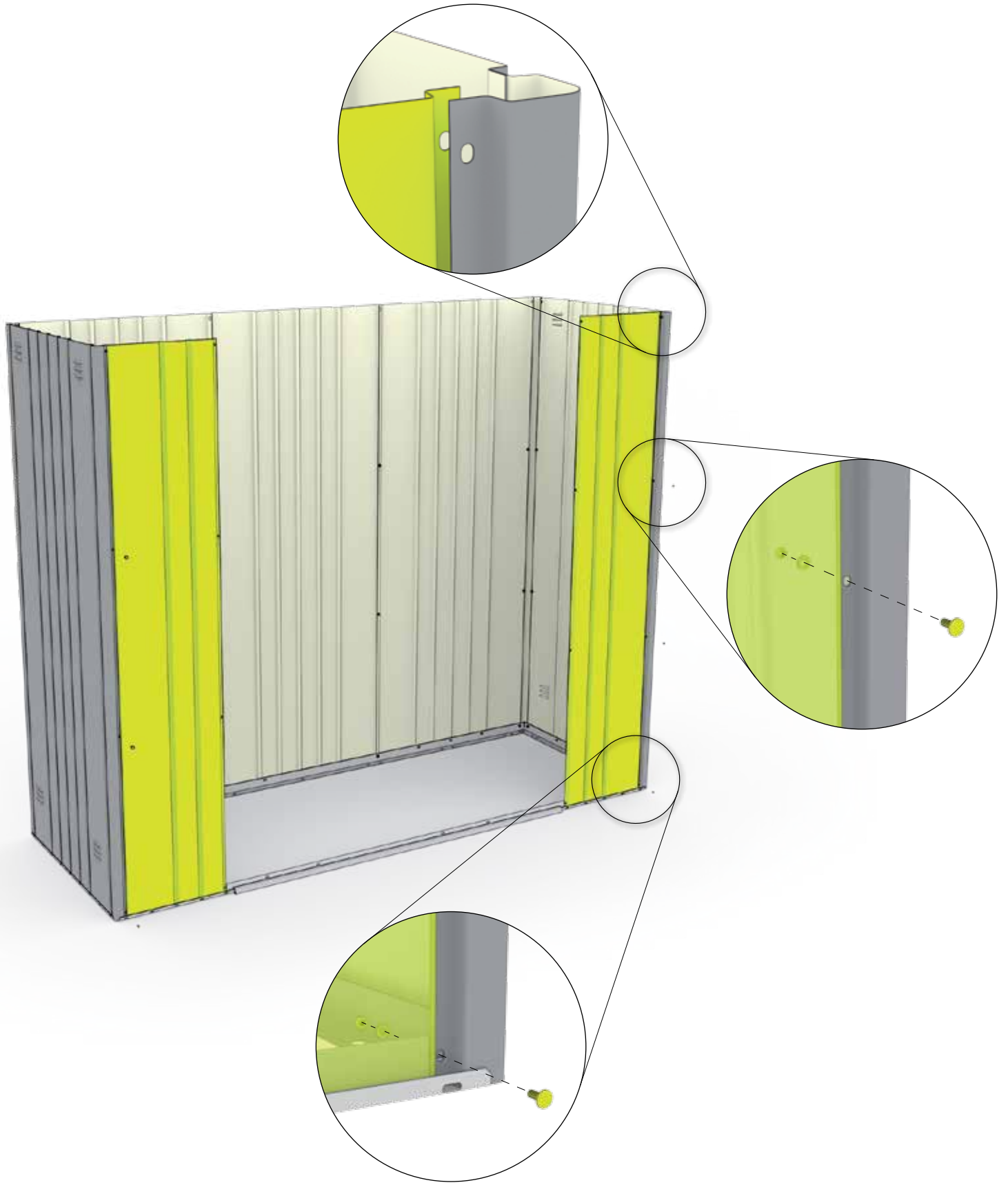
 <p>GS 230: 2x</p> <p>(A)</p>	<p>M4 x 10</p>  <p>(D2)</p>	<p>GS 230: 6x</p>
---	---	-------------------



10.

2

	GS 150: 2x		GS 150: 6x
	GS 230: 2x		GS 230: 6x

M

D2

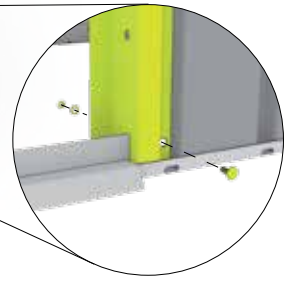
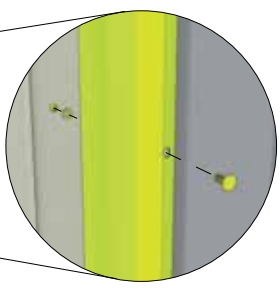
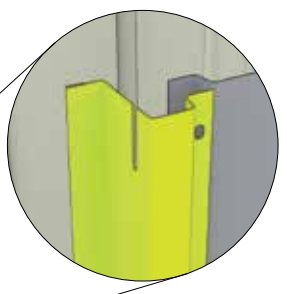
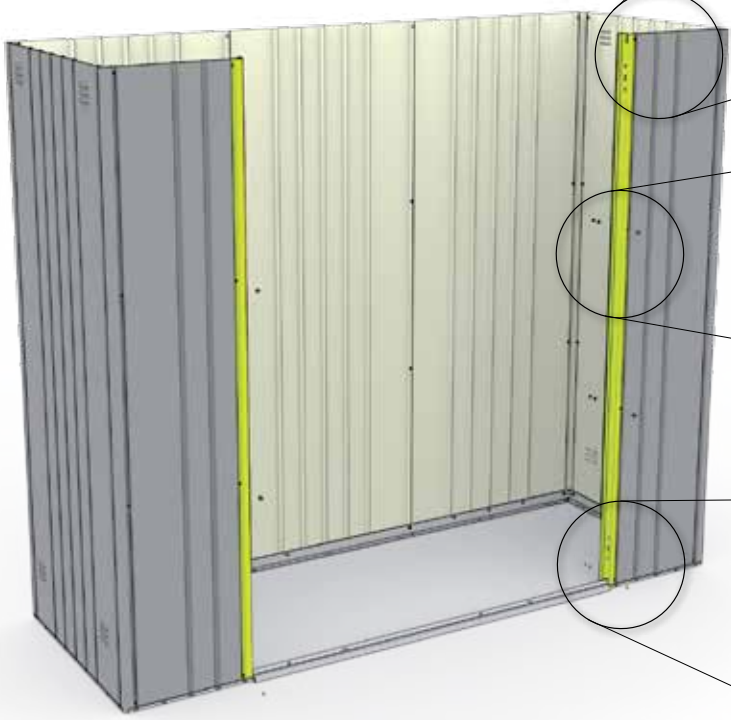

Größenabhängiger Montageschritt - Size-Dependent assembly step - Dépendant de la taille - Size-Dependent montagestep

Nur für Größe 150



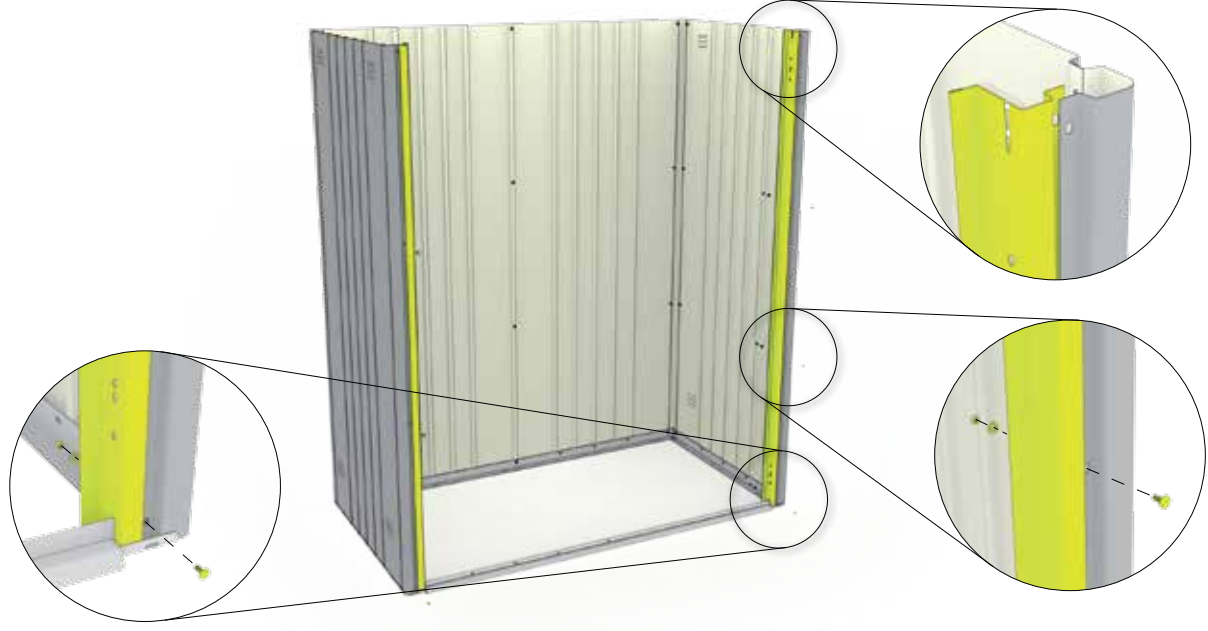

Only for width 150 · Juste pour la largeur de 150 · Alleen voor breedte 150 · sólo para el ancho de 150 · solo per larghezza 150

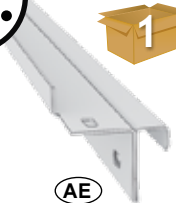

Size-Dependent assembly step - Paso de montaje de tamaño Dependiente - Taglia-Dependent fase di montaggio

11.



 (AE)	GS 150: 2x (770mm)	M4 x 10	  	GS 150: 2x
	GS 230: 2x (770mm)			GS 230: 2x

(D2)

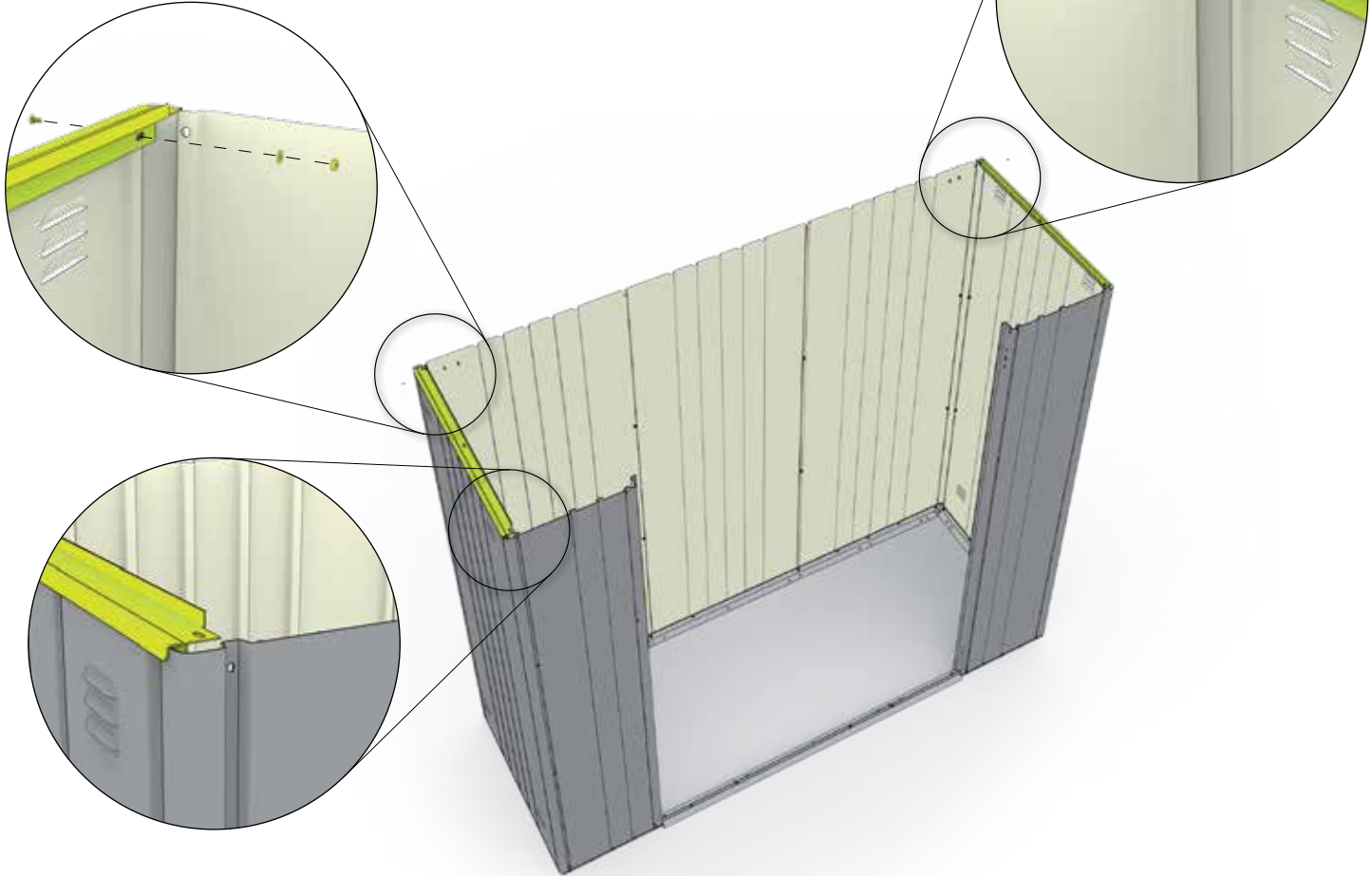

Größenabhängiger Montageschritt - Size-Dependent assembly step - Dépendant de la taille - Size-Dependent montagestep





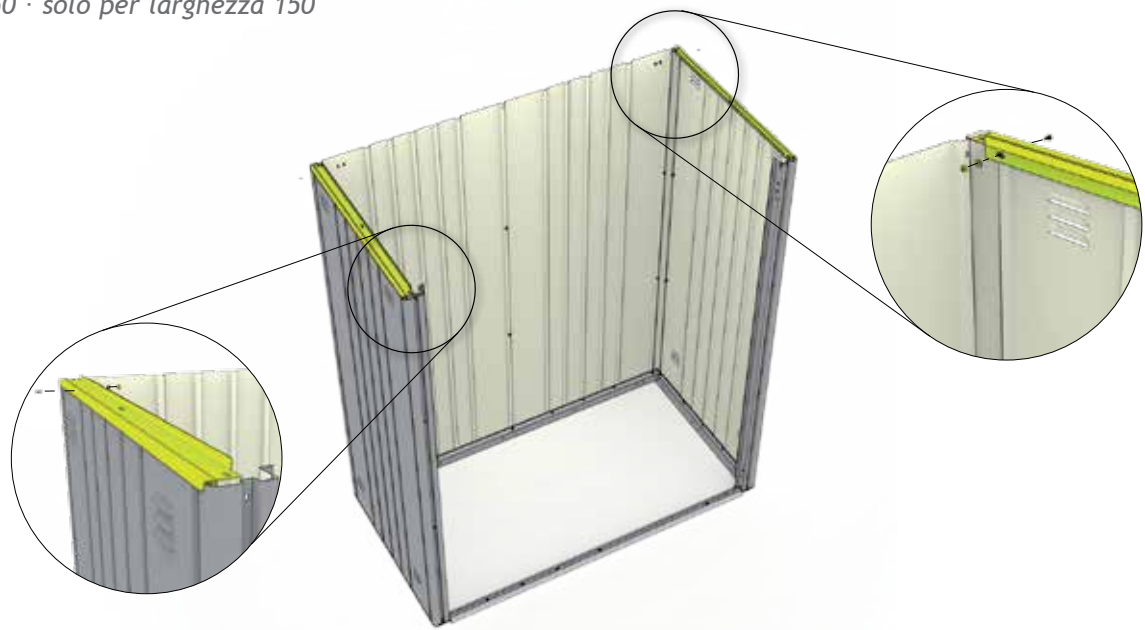

Nur für Größe 150

Only for width 150 · Juste pour la largeur de 150 · Alleen voor breedte 150 · sólo para el ancho de 150 · solo per larghezza 150

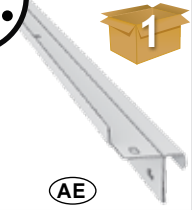

Size-Dependent assembly step - Paso de montaje de tamaño Dependiente - Taglia-Dependent fase di montaggio

12.

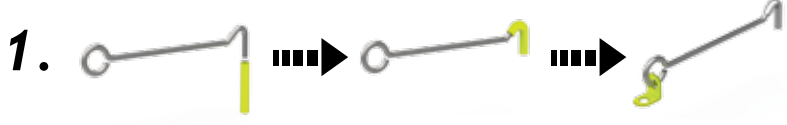
 <p>(AE)</p>	<p>GS 150: 2x (1490mm) GS 230: 2x (2210mm)</p>	 <p>(AD)</p>	<p>GS 150: 2x GS 230: 2x</p>	 <p>(D2)</p>	<p>GS 150: 5x GS 230: 8x</p>
 <p>(D1)</p>	<p>GS 150: 2x GS 230: 2x</p>	 <p>(D1)</p>	<p>GS 150: 2x GS 230: 2x</p>	 <p>(D1)</p>	<p>GS 150: 2x GS 230: 2x</p>
<p>M4 x 18</p>  <p>(D2)</p>	<p>GS 150: 2x GS 130: 2x</p>	<p>1.</p> 			

2.

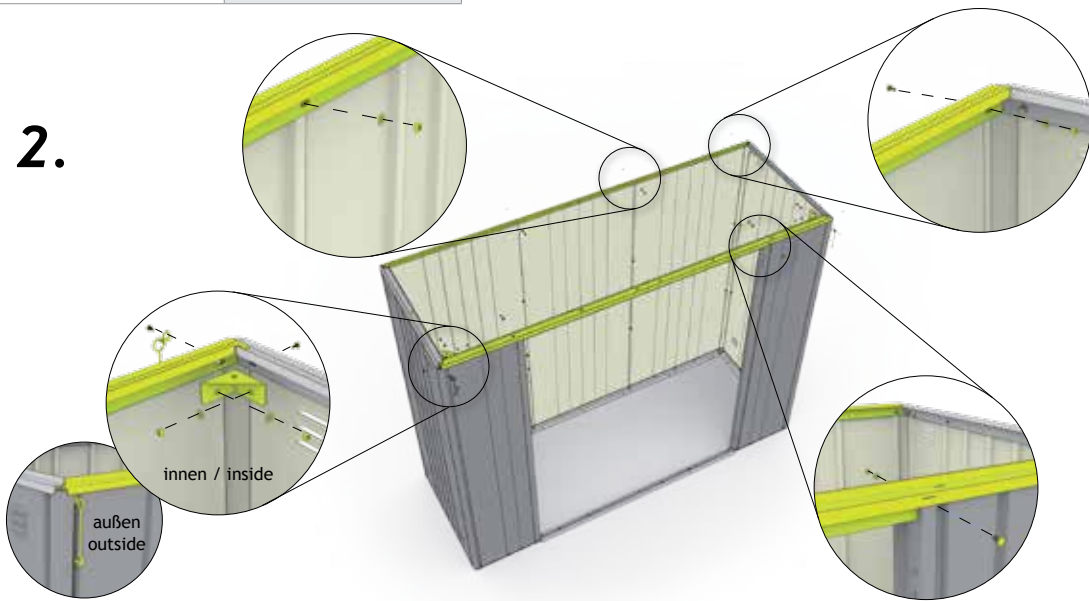

Größenabhängiger Montageschritt - Size-Dependent assembly step - Dépendant de la taille - Size-Dependent montagestep

Nur für Größe 150

Only for width 150 · Juste pour la largeur de 150 · Alleen voor breedte 150 · sólo para el ancho de 150 · solo per larghezza 150

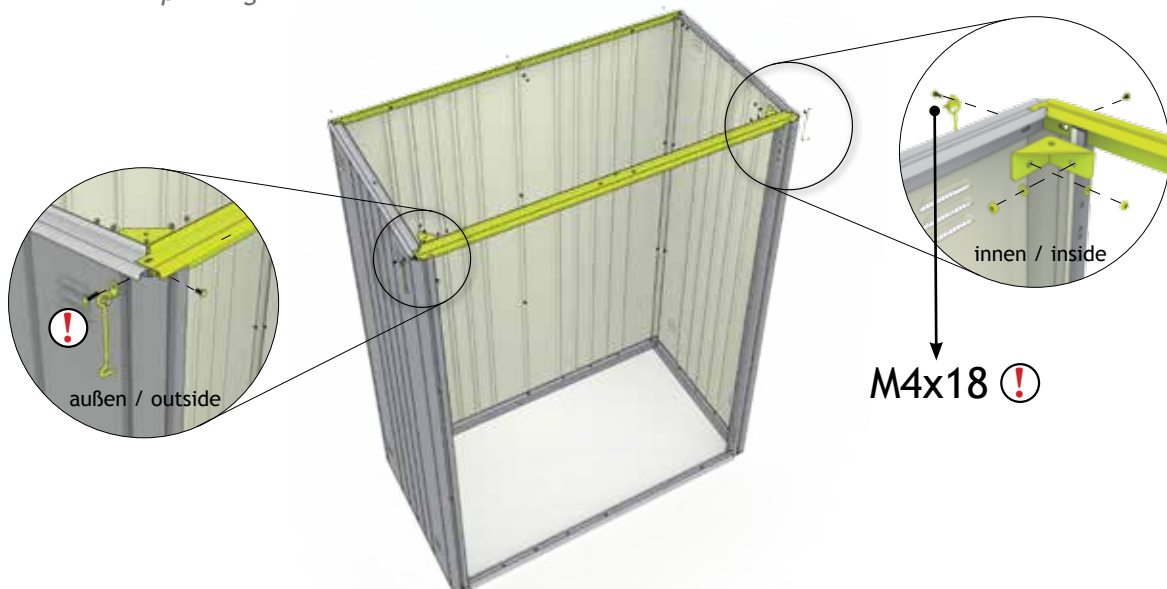

Size-Dependent assembly step - Paso de montaje de tamaño Dependiente - Taglia-Dependent fase di montaggio

13.

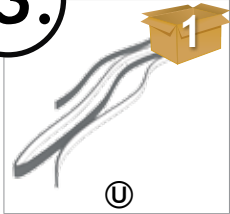

GS 150: 2x (2850mm)

GS 230: 2x (2850mm)

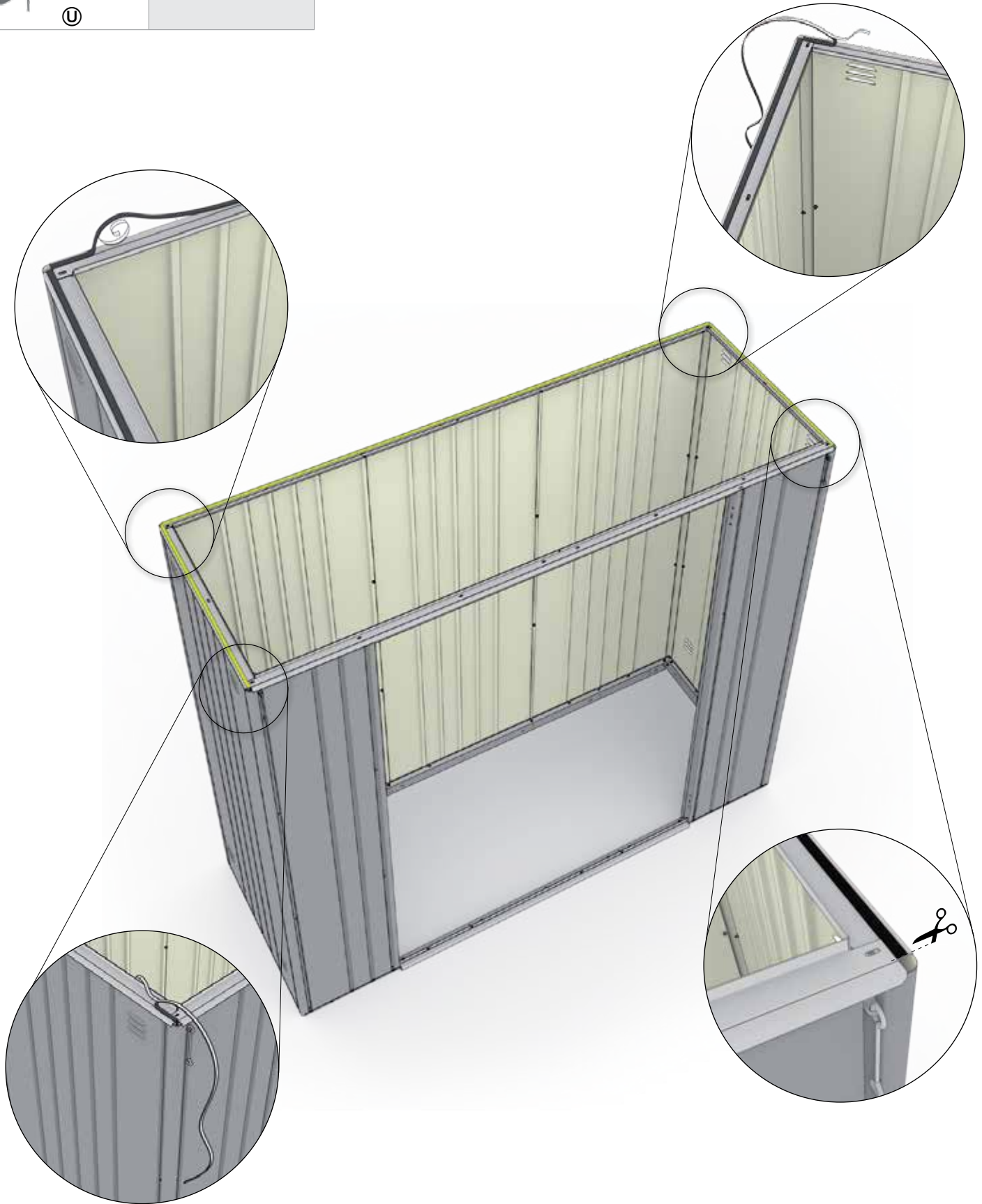

14.

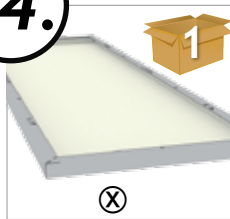

GS 150: 1x
GS 230: 1x

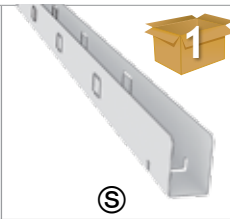

GS 150: 2x
GS 230: 3x

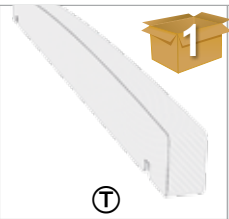

GS 150: 2x
GS 230: 3x

1.

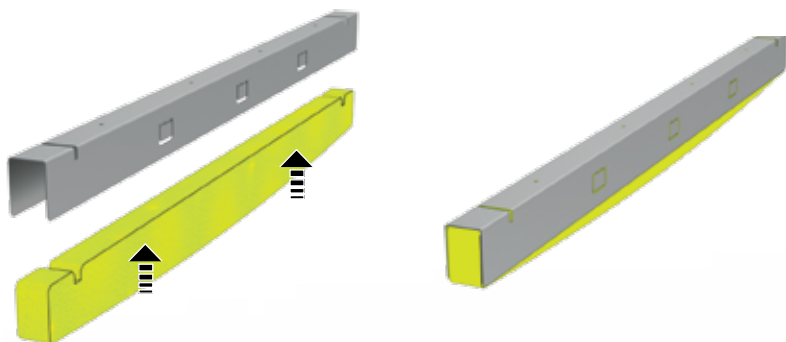

2.

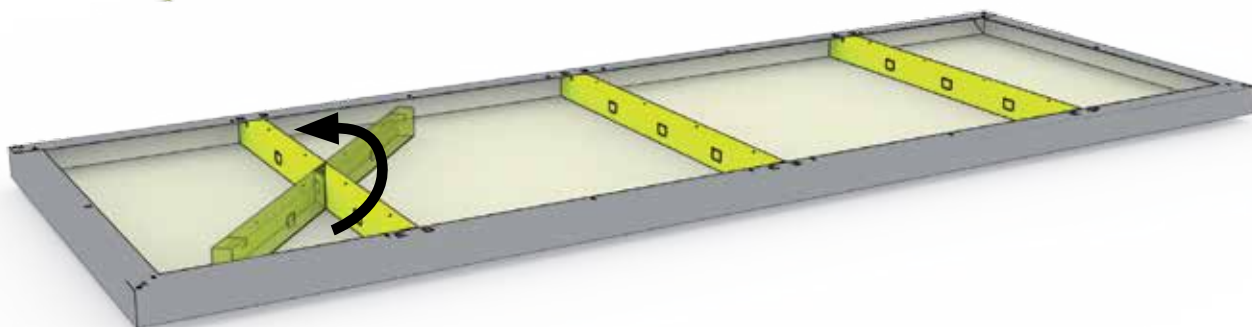

3.

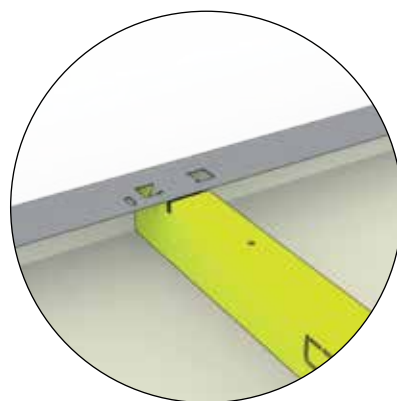
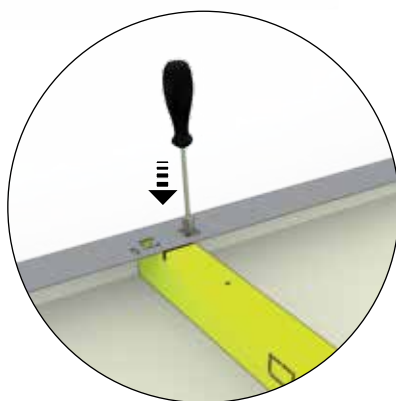
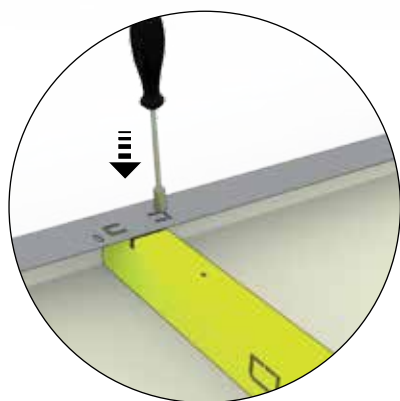

4.



15.

M4 x 10



GS 150: 8x

GS 230: 18x

D2

1.

2.

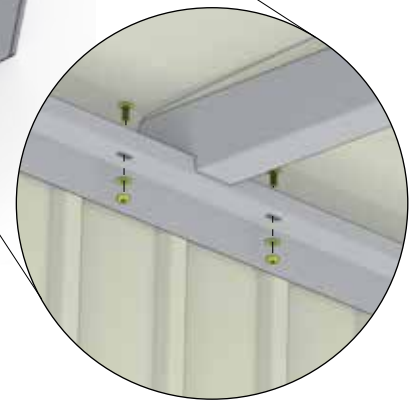
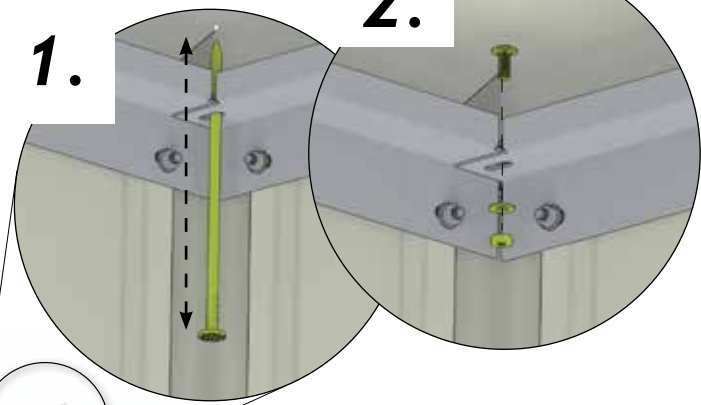
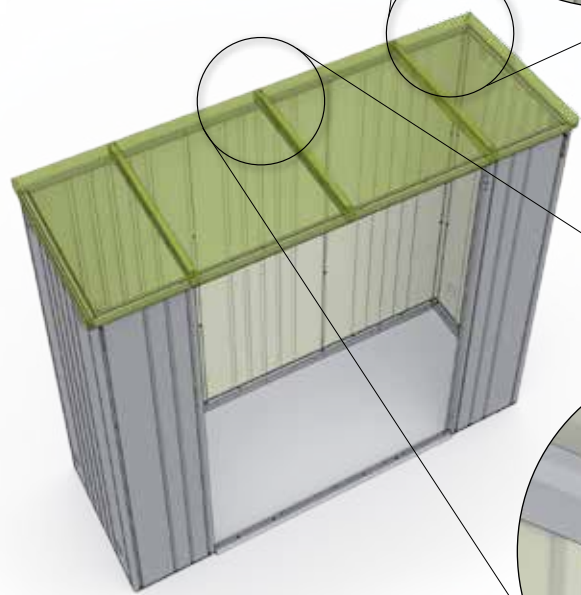

Größenabhängiger Montageschritt - Size-Dependent assembly step - Dépendant de la taille - Size-Dependent montagestep



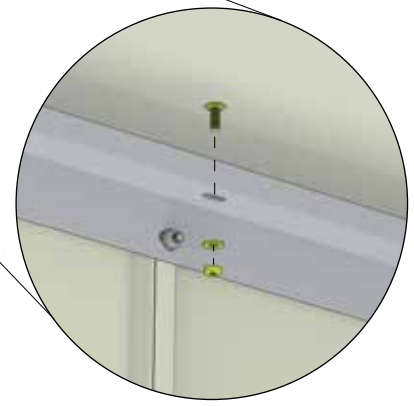

Nur für Größe 150

Only for width 150 · Juste pour la largeur de 150 · Alleen voor breedte 150 · sólo para el ancho de 150 · solo per larghezza 150





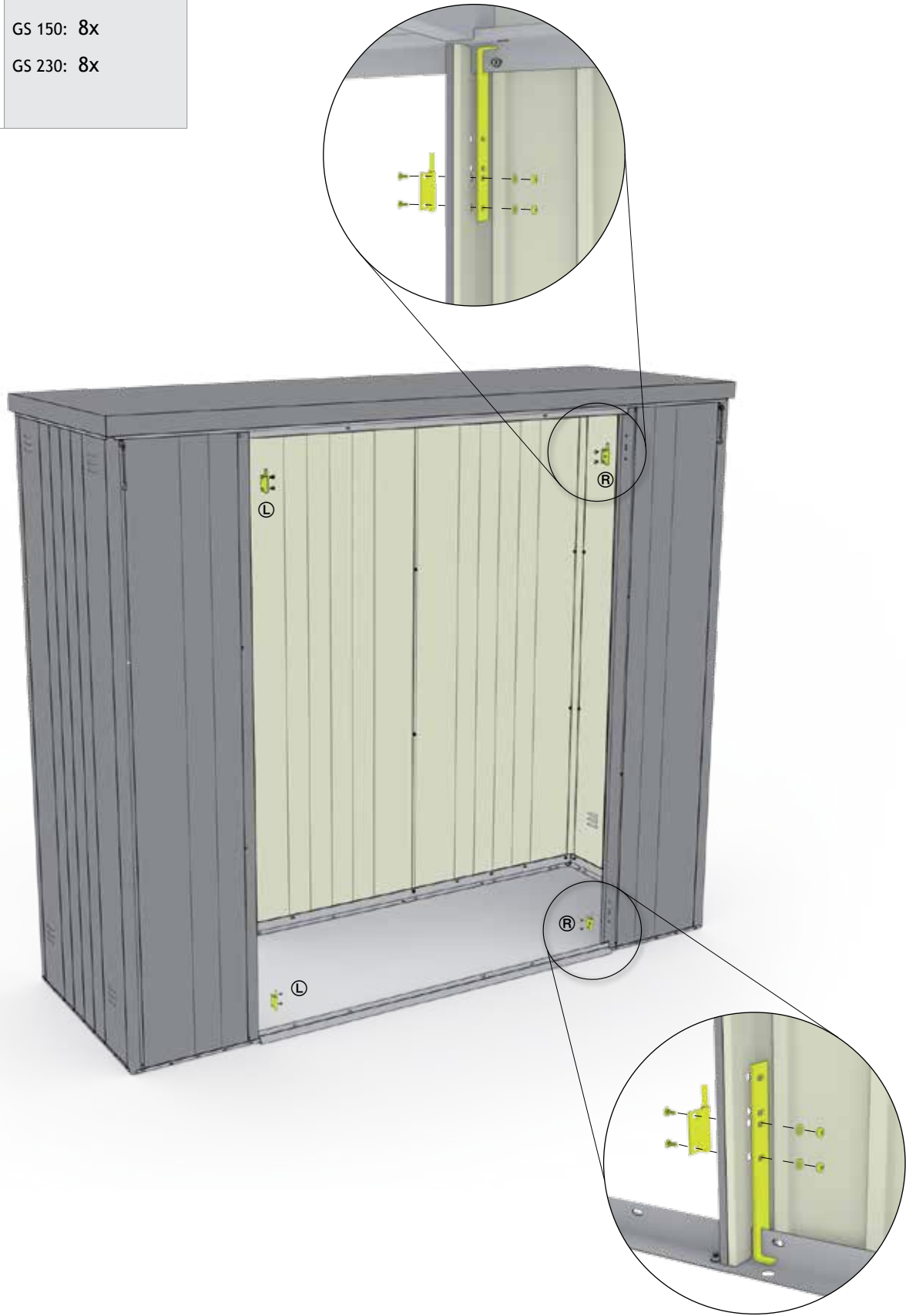

Size-Dependent assembly step - Paso de montaje de tamaño Dependiente - Taglia-Dependent fase di montaggio

16.

 <p>(D1)</p>	<p>GS 150: 4x GS 230: 4x</p>	 <p>(D1)</p>	<p>GS 150: 2x GS 230: 2x</p>	 <p>(D1)</p>	<p>GS 150: 2x GS 230: 2x</p>
<p>M4 x 10</p>  <p>(D2)</p>	<p>GS 150: 8x GS 230: 8x</p>				



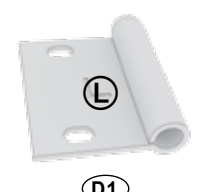
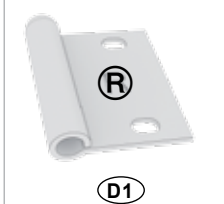
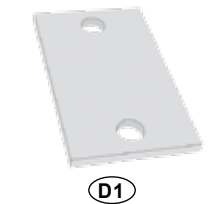

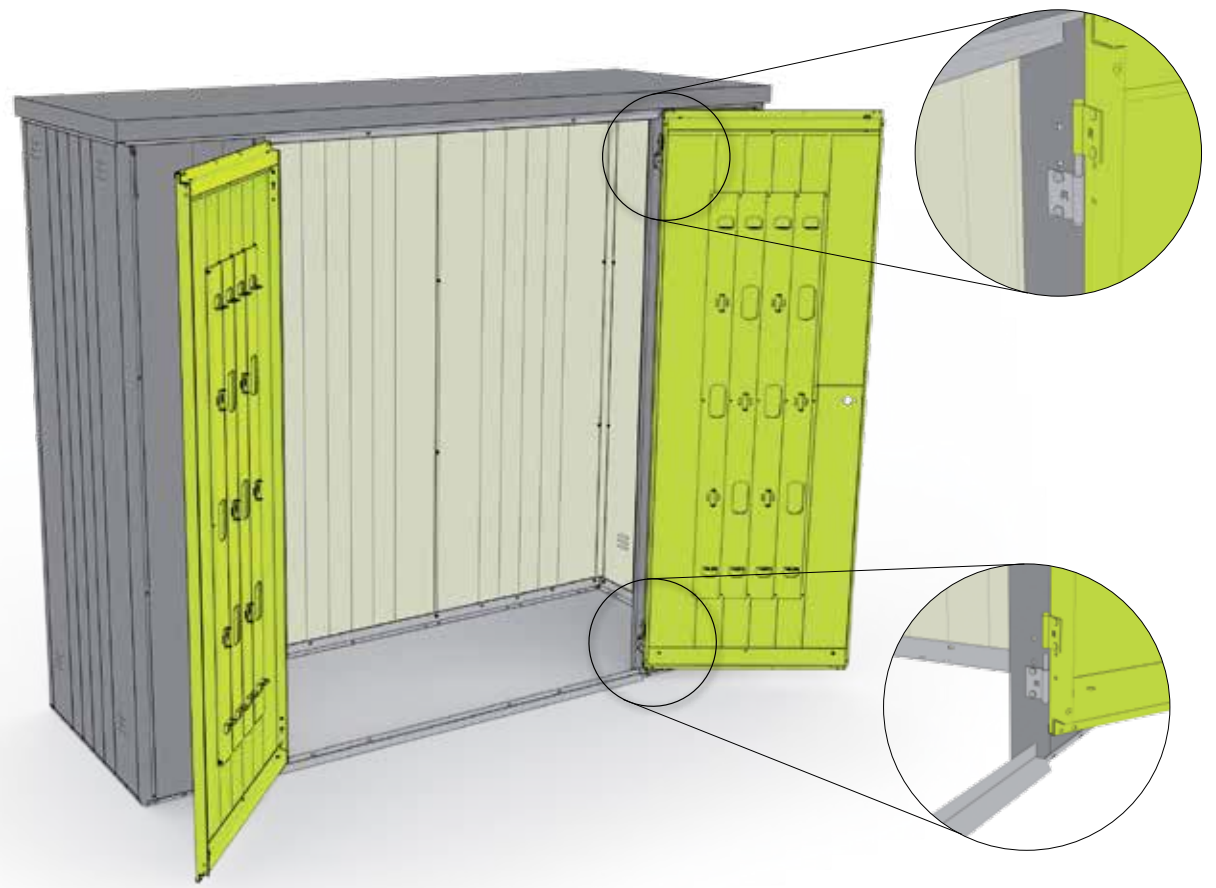
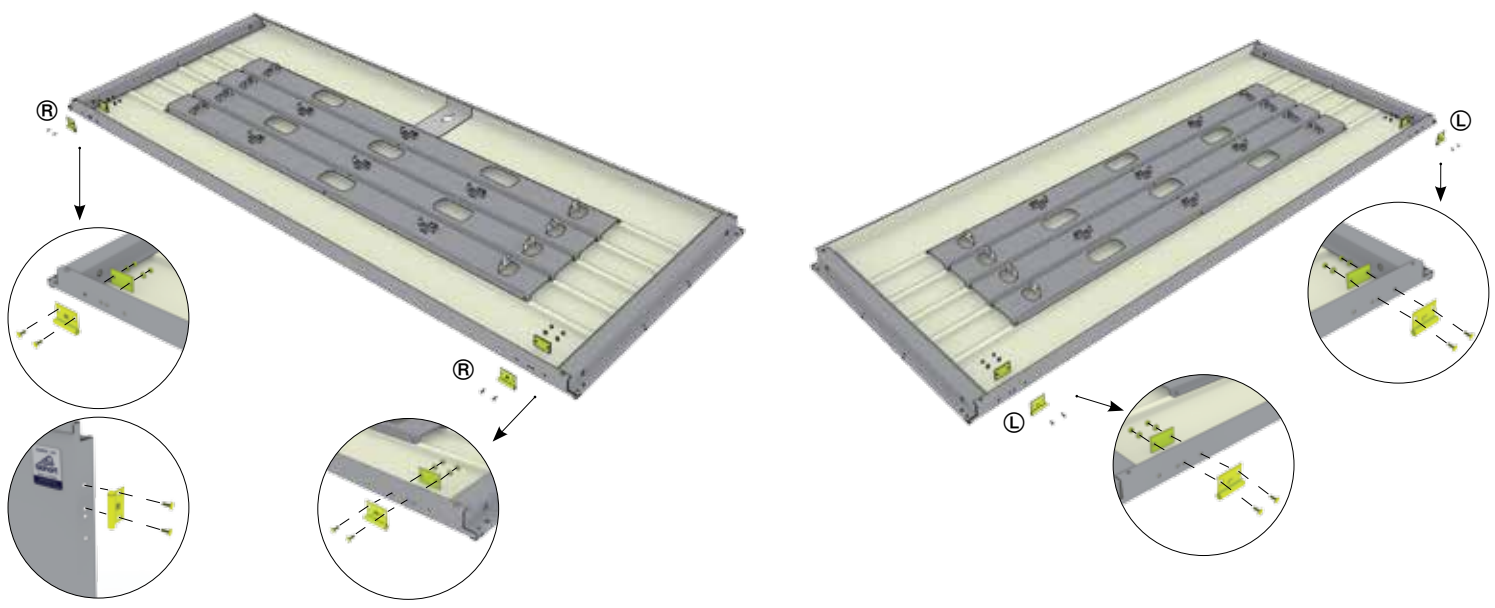

17.

 <p>B</p>	<p>GS 150: 1x GS 230: 1x</p>	 <p>C</p>	<p>GS 150: 1x GS 230: 1x</p>	 <p>D1</p>	<p>GS 150: 2x GS 230: 2x</p>
 <p>D1</p>	<p>GS 150: 2x GS 230: 2x</p>	 <p>D1</p>	<p>GS 150: 4x GS 230: 4x</p>	<p>M4 x 10</p>  <p>D2</p>	<p>GS 150: 8x GS 230: 8x</p>



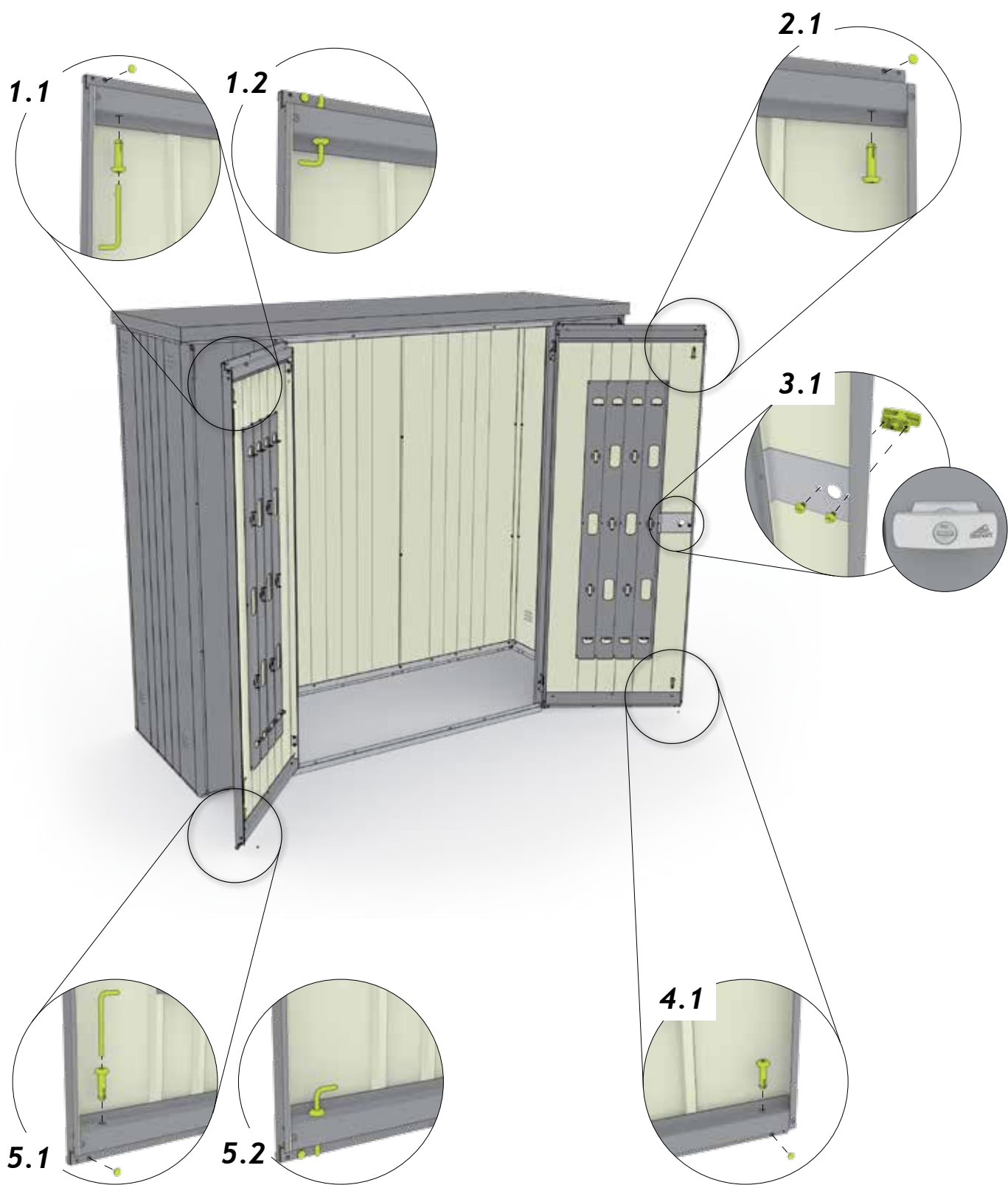

18.

 <p>(D1)</p>	<p>GS 150: 2x GS 230: 2x</p>	 <p>(D1)</p>	<p>GS 150: 4x GS 230: 4x</p>	 <p>(D1)</p>	<p>GS 150: 1x GS 230: 1x</p>
<p>M6 x 8</p>  <p>(D1)</p>	<p>GS 150: 2x GS 230: 2x</p>	 <p>(D1)</p>	<p>GS 150: 4x GS 230: 4x</p>		



19.

 D1	GS 150: 1x GS 230: 1x	 I	2 GS 150: 2x GS 230: 2x	M6 x 8  D1	GS 150: 1x GS 230: 1x
---	--------------------------	---	-------------------------------	---	--------------------------

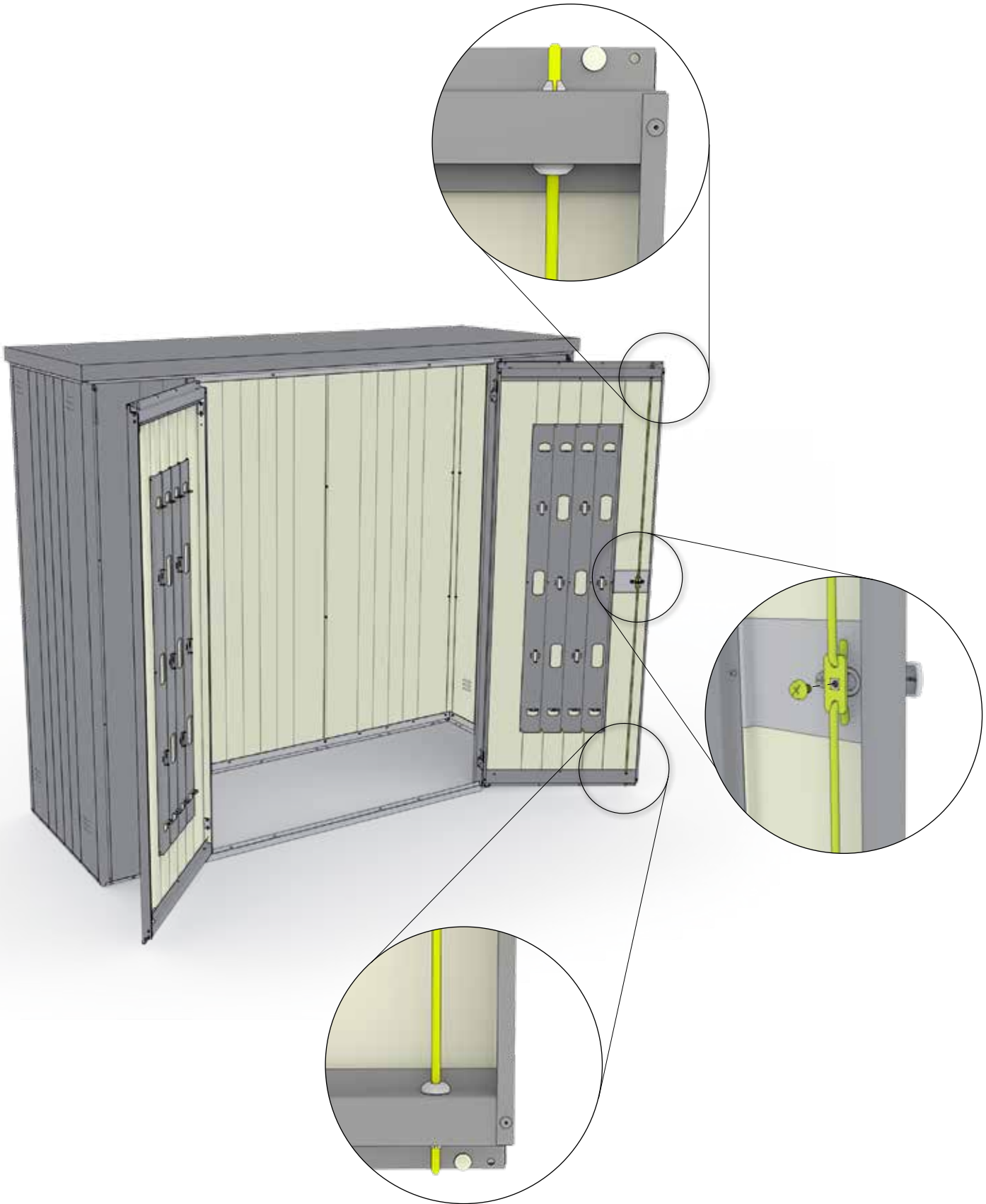

20.

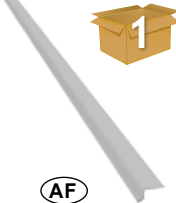
 GS 150: 1x (2850mm) GS 230: 1x (2850mm) Ⓚ	 GS 150: 1x GS 230: 1x ⒶF
--	---

1.

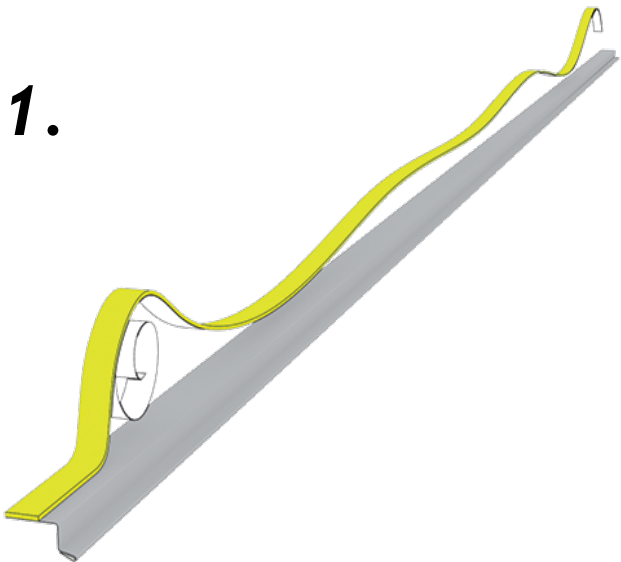

2.

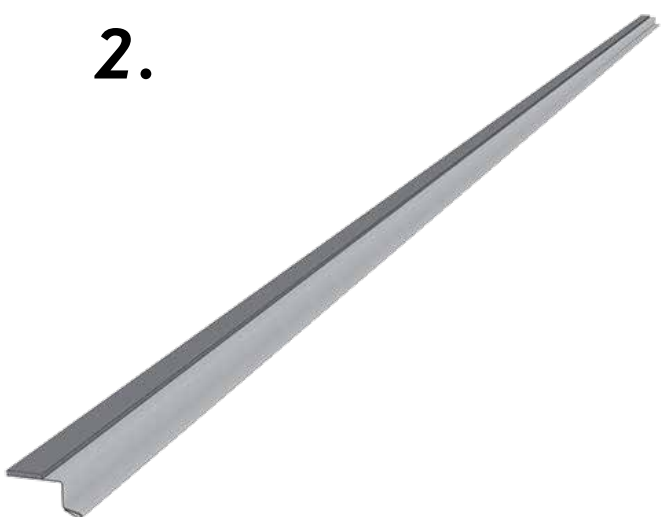

1.1

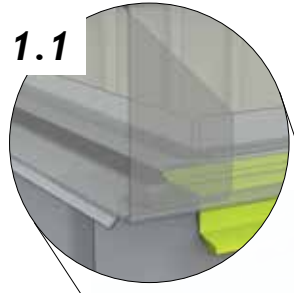

1.2

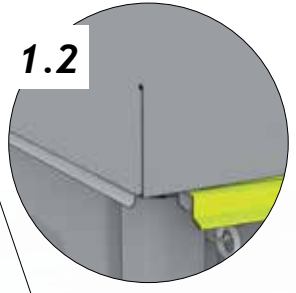

2.1



2.2

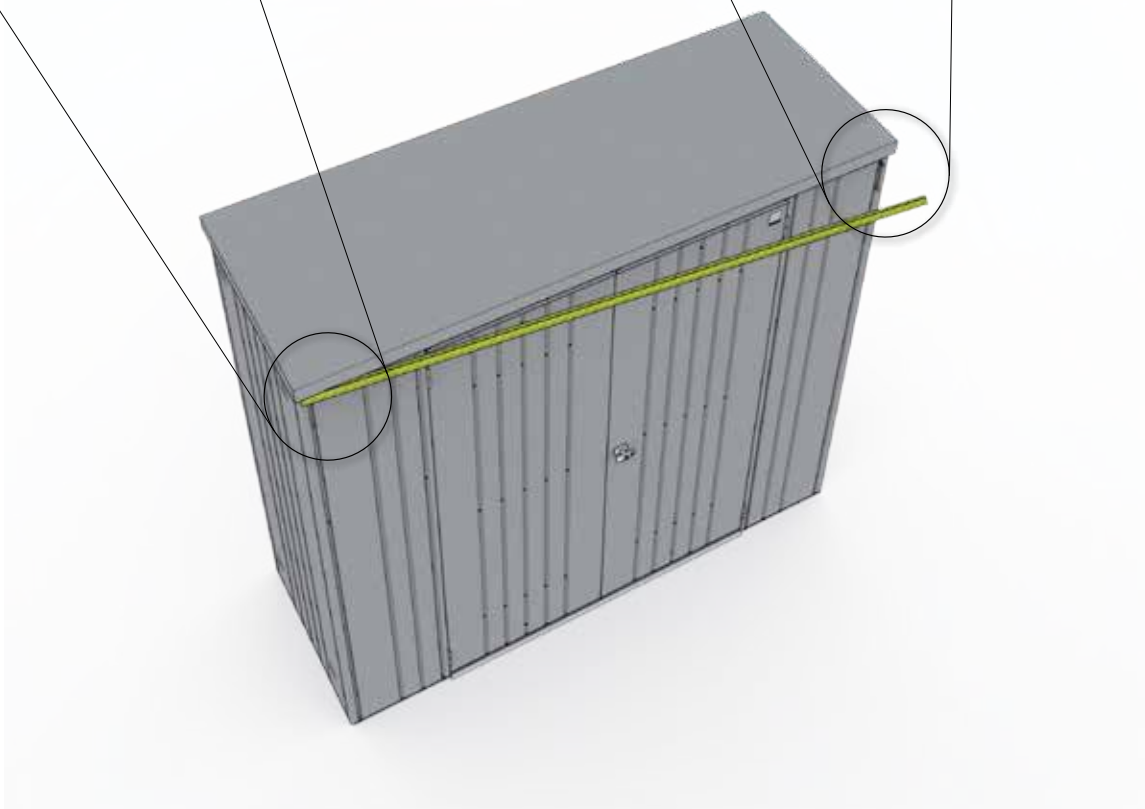

21.



D2

GS 150: 70x

GS 230: 70x

Rechtwinkelig einrichten

- Ⓒ rectangular adjusted
- Ⓕ ajuster en forme rectangulaire
- Ⓖ rechthoekig instellen
- Ⓔ ajustar en forma rectangular
- Ⓙ Mettere in squadra

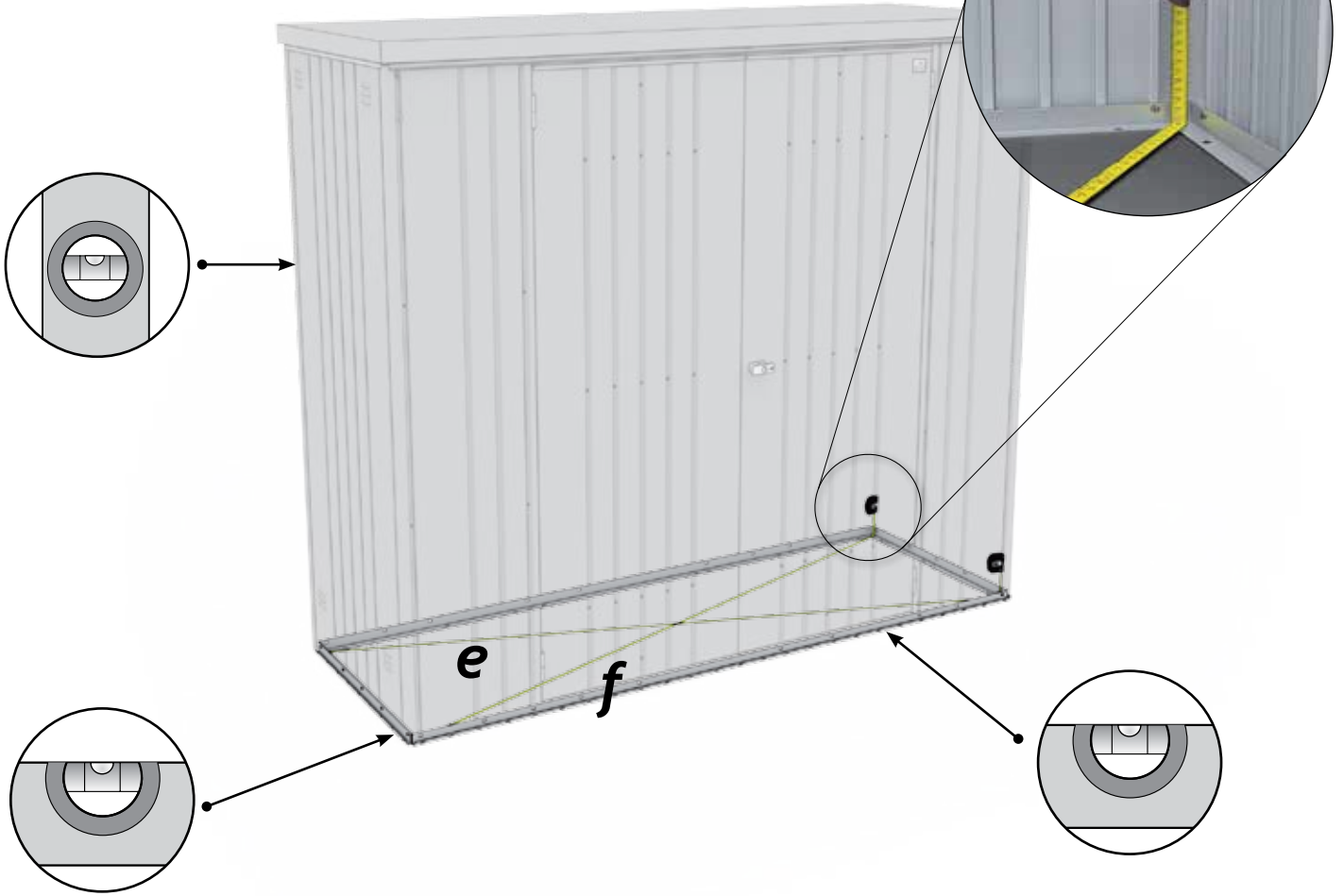

$$e = f$$



Ziehen Sie jetzt alle Schraubenverbindungen fest an!

Tighten now all nuts and connections securely! - Serrez maintenant les vis à fond!
 - Draai nu alle schroeven vast! - Ahora puede apretar y fijar todos los tornillos y tuercas - Adesso serrare a fondo tutti i dadi!

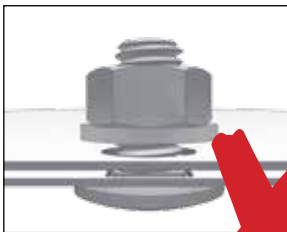

22.

Tür einrichten

- Ⓒ align the door
- Ⓕ ajuster la porte
- Ⓓ deur afstellen
- Ⓔ ajuste la puerta
- Ⓙ messa a squadra della porta

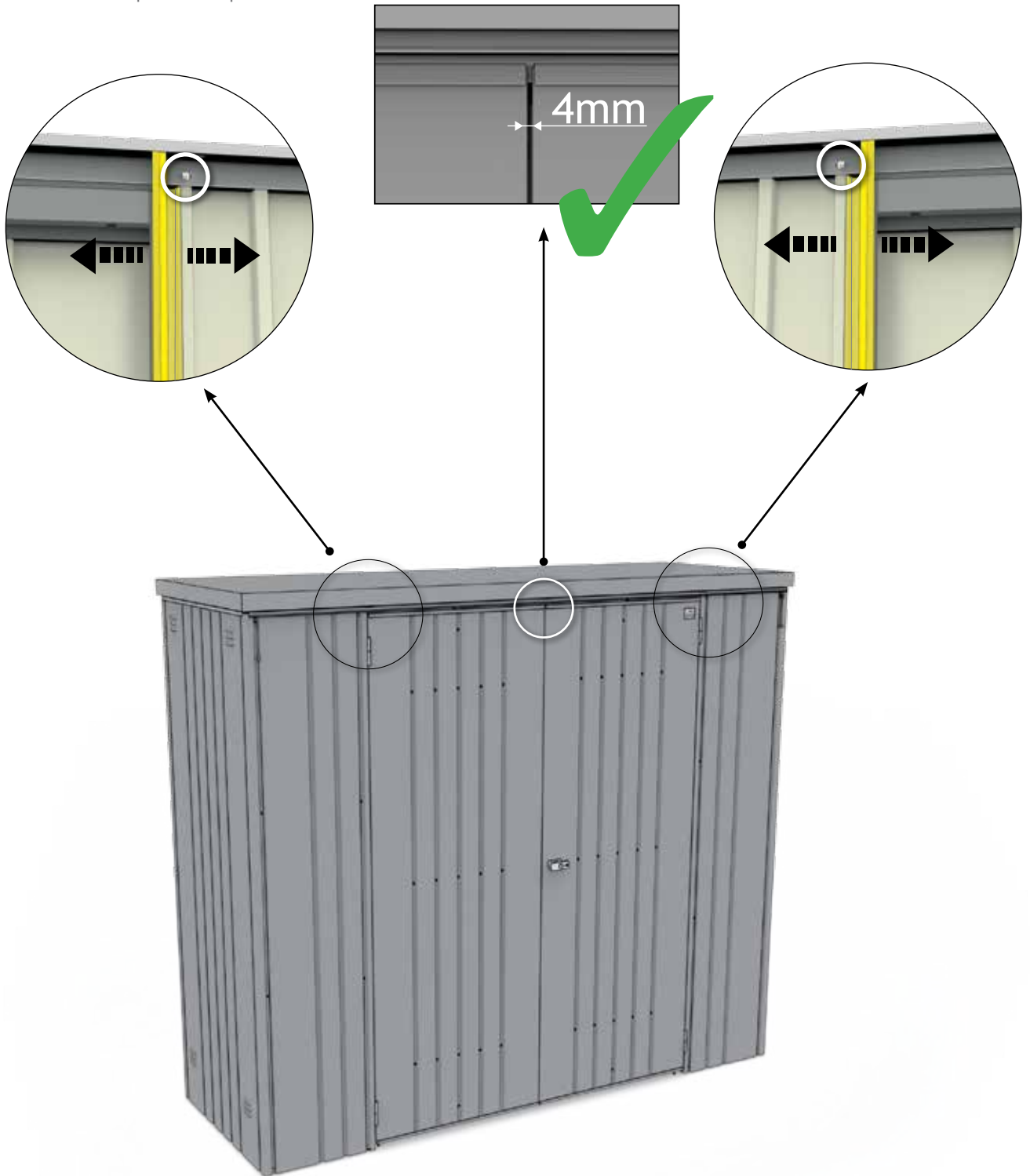

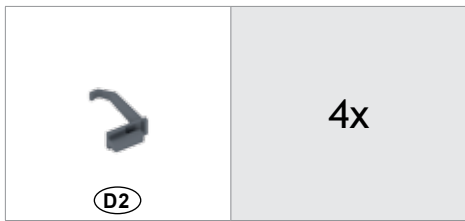

Funktion Windhaken

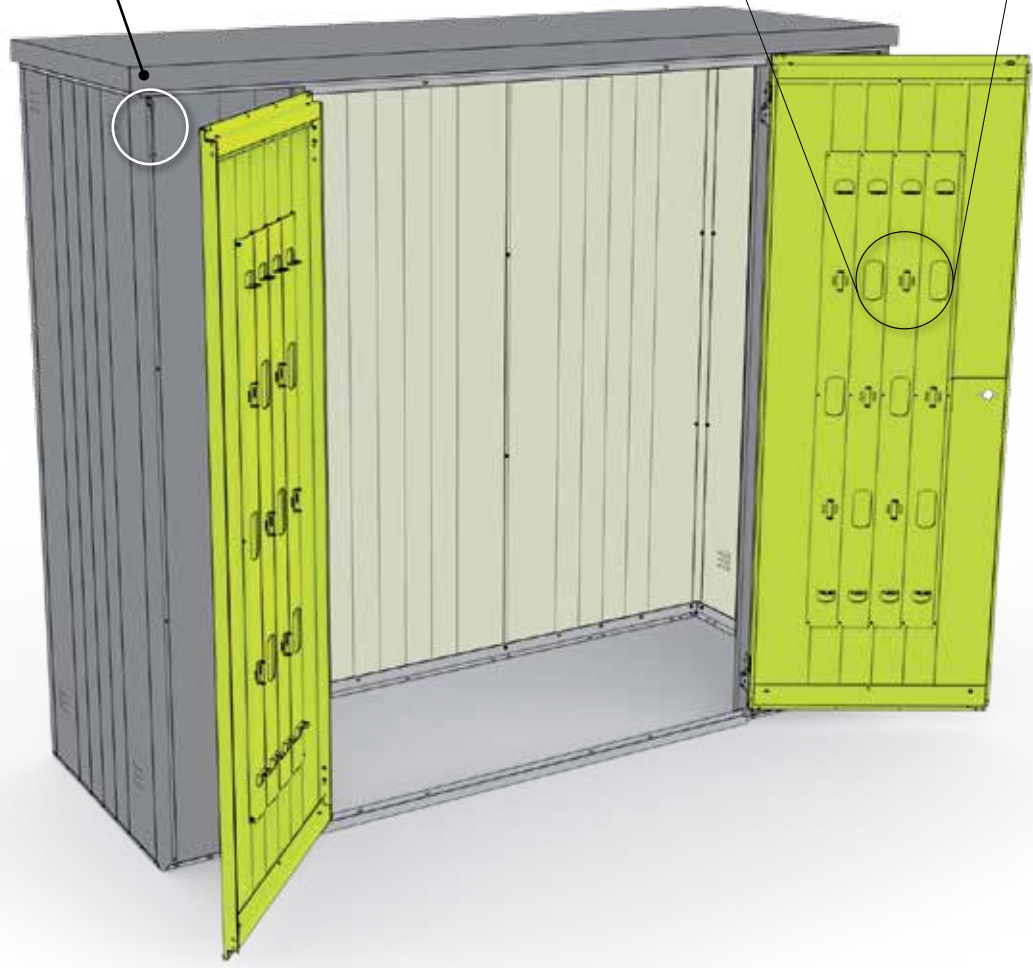
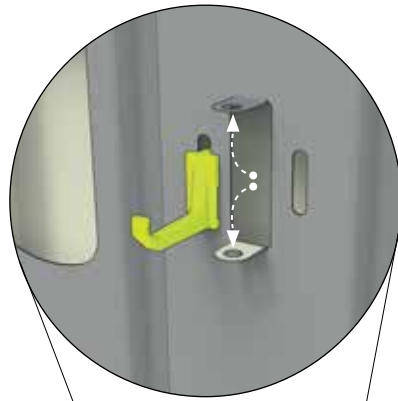
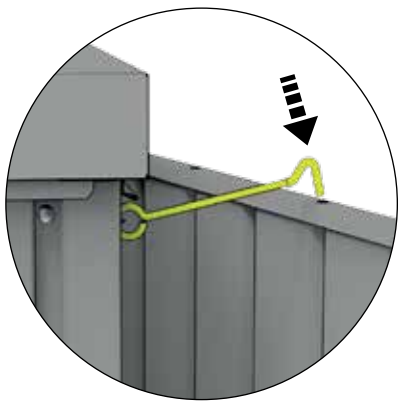

- ⒸB Function of the door hooks
- ⒹR fonction des crochets de porte
- ⒹL Functie van windhaken
- ⒹS Función de los topes de seguridad
- ⒹT Funzione gancio fermaporta





Bodenrahmen

Floor Frame - Cadre de sol - Telaio perimetrale - Bodemframe - marco de suelo

 <p>ZB</p>	<p>GS 150: 2x (1420mm) GS 230: 2x (2140mm)</p>	 <p>ZB</p>	<p>GS 150: 2x (700mm) GS 230: 2x (700mm)</p>	 <p>ZC</p>	<p>GS 150: 4x GS 230: 4x</p>
--	--	--	--	--	----------------------------------

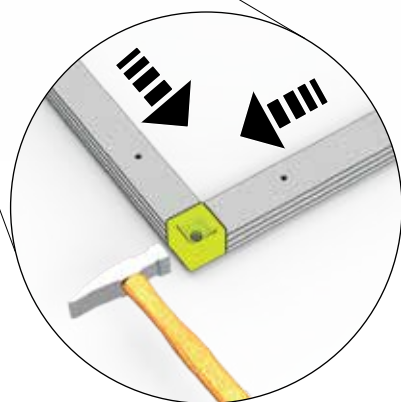

 <p>(ZD)</p>	<p>GS 150: 4x GS 230: 6x</p>	 <p>(ZF)</p>	<p>GS 150: 12x GS 230: 12x</p>
---	----------------------------------	---	------------------------------------

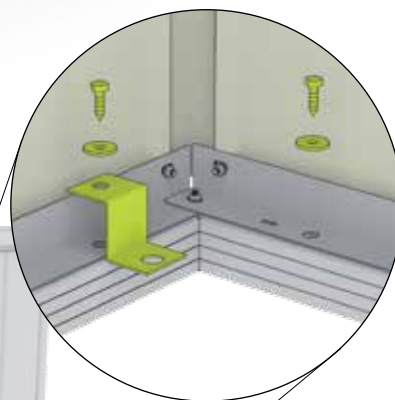
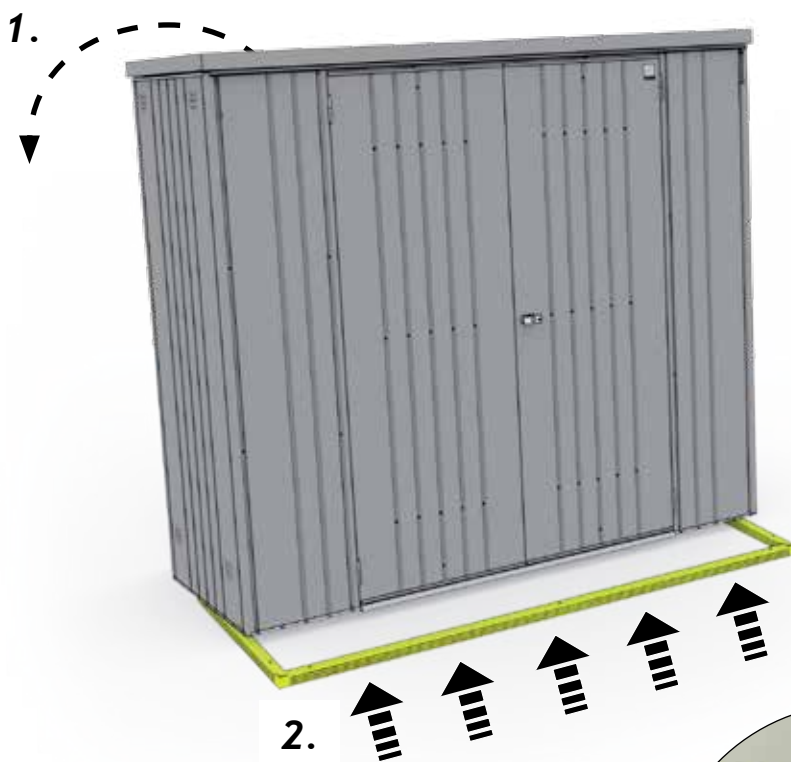



Bodenrahmen

Floor Frame - Cadre de sol - Telaio perimetrale - Bodemframe - marco de suelo

Variante 1 - (Seite 5), Proposal 1 - (page 5), Variant 1 - (page 5)

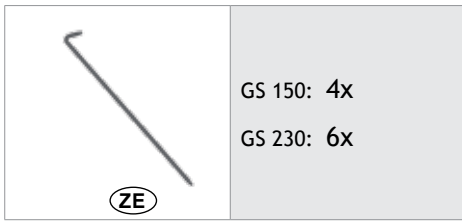

Variante 2 - (Seite 5), Proposal 2 - (page 5), Variant 2 - (page 5)

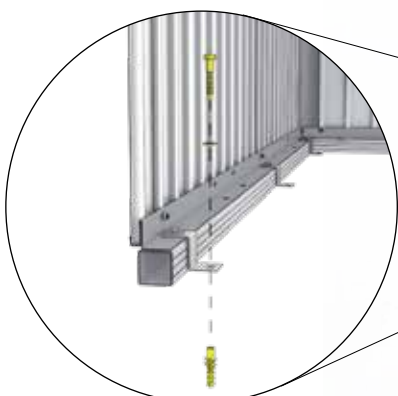
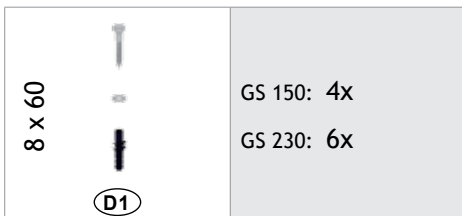



23.

8 x 60		GS 150: 6x
		GS 230: 6x
(D1)		

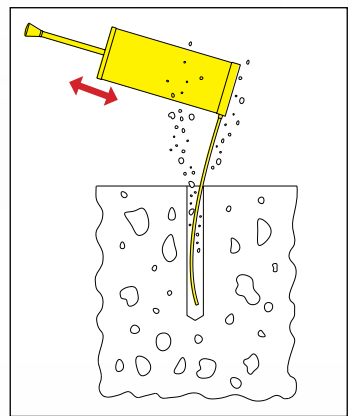
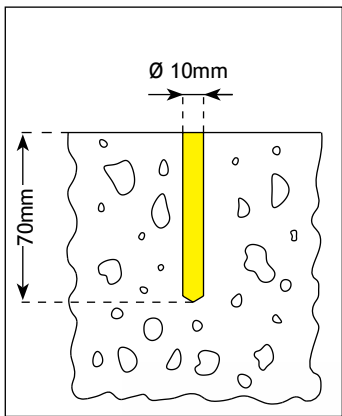
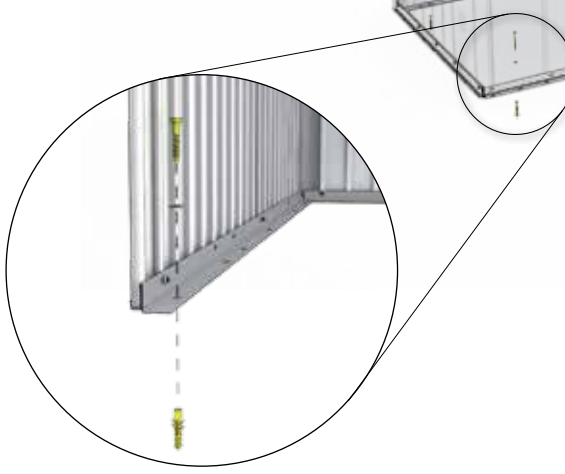
Variante 3 - (Seite 5), Proposal 3 - (page 5), Variant 3 - (page 5)



24.

		GS 150: 4x
		GS 230: 4x
(A1)		



25.

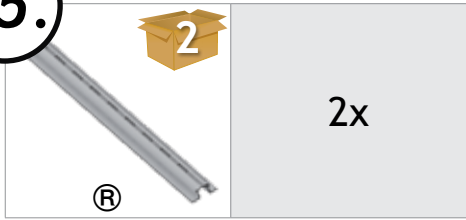

1.

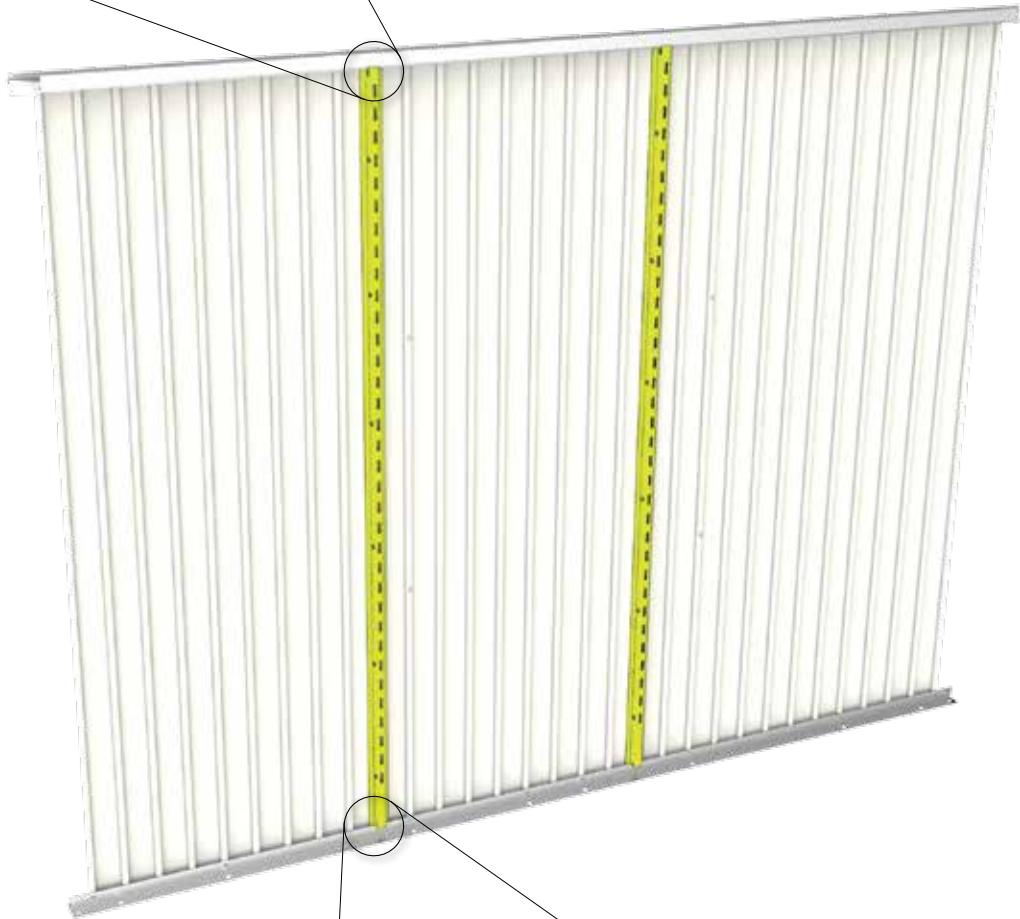
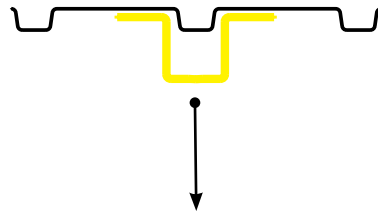
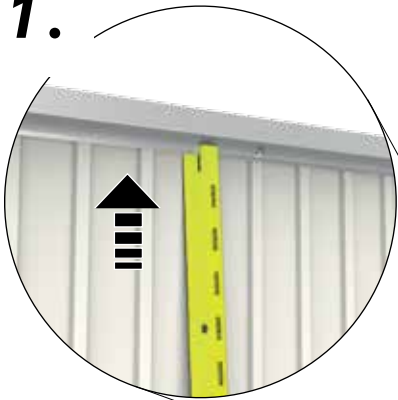

2.

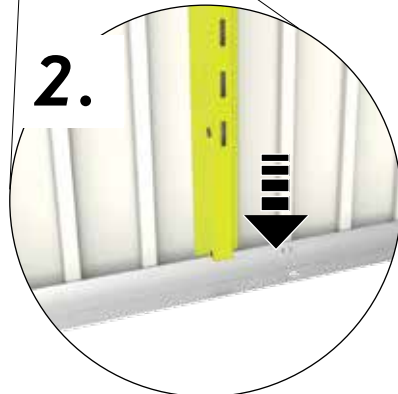

3.

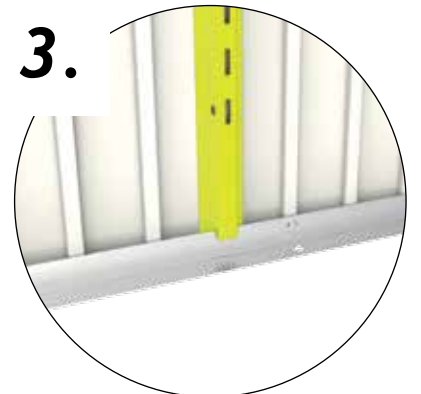

26.



Option 1:

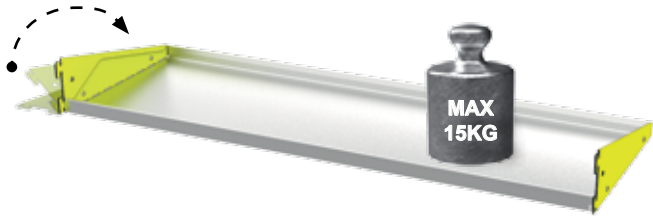

Option 2:

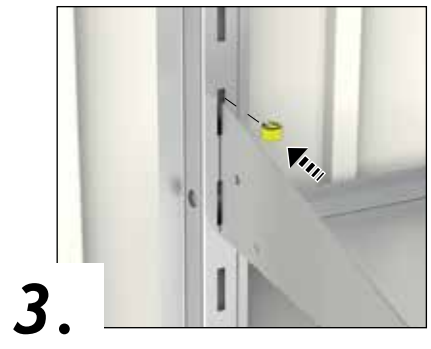
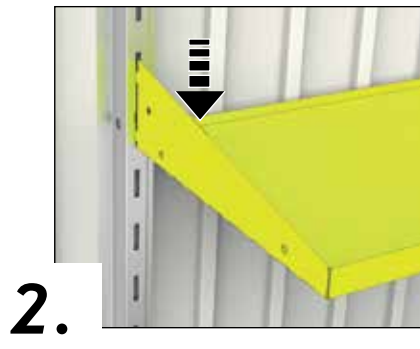
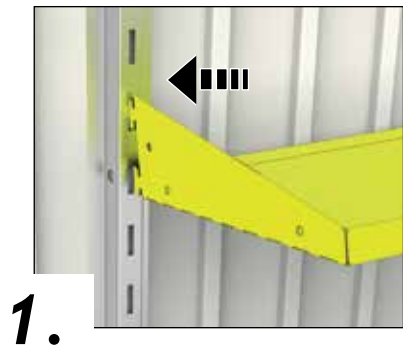
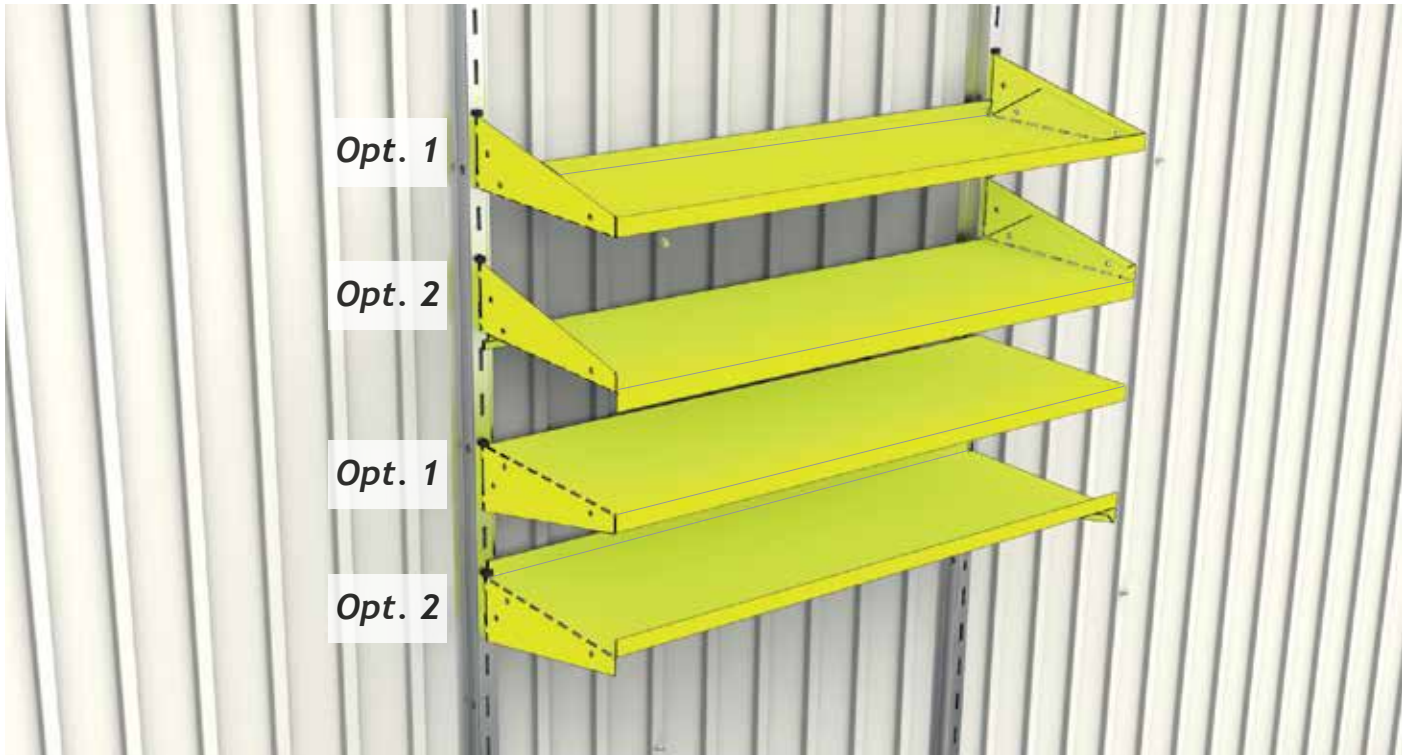



HighLine®

Das ultimative Gerätehaus, das auch hinsichtlich Sicherheit und Funktionalität alle Anforderungen erfüllt: erhältlich in 5 Größen und in 3 Farben - weiß, silber-metallic, dunkelgrau-metallic



AvantGarde

Passt bestens zu moderner Architektur und macht lebenslang Freude: erhältlich in 4 Größen und in 3 Farben - silber-metallic, quarzgrau-metallic, dunkelgrau-metallic



Europa

Alles in bester Ordnung und lebenslange Wartungsfreiheit mit dem Biohort-Klassiker: erhältlich in 9 Größen und in 4 Farben - silber-metallic, quarzgrau-metallic, dunkelgrau-metallic, dunkelgrün



Geräteschrank

Wo Raum knapp ist, zeigt er seine Klasse – im Garten, auf der Terrasse, in der Garage: erhältlich in 2 Größen und in 4 Farben - silber-metallic, quarzgrau-metallic, dunkelgrau-metallic, dunkelgrün



WoodStock®

Kaminholzlager und Geräteschrank in einem, auch zum einfachen Wand-Anbau geeignet: erhältlich in 2 Größen und in 2 Farben - silber-metallic, dunkelgrau-metallic



StoreMax®

Mit seinem funktionellen Design bietet der StoreMax® maximalen Stauraum auf wenig Platz: erhältlich in 3 Größen und in 3 Farben - silber-metallic, quarzgrau-metallic, dunkelgrau-metallic



HighBoard

Das formvollendete Multitalent zum Aufbewahren: erhältlich in 2 Größen und in 3 Farben - weiß, silber-metallic, dunkelgrau-metallic



LoungeBox®

Die Design-Box für gehobene Ansprüche - ein Schmuckstück für Terrasse und Garten: erhältlich in 3 Farben - weiß, silber-metallic, dunkelgrau-metallic



FreizeitBox

Sie steckt locker all das weg, wofür Sie keinen geeigneten Aufbewahrungsort haben: erhältlich in 4 Größen und in 5 Farben - weiß, silber-metallic, quarzgrau-metallic, dunkelgrau-metallic, dunkelgrün



Nebengebäude „CasaNova®“

Das erste isolierte Design-Nebengebäude: erhältlich in 9 Größen und in 2 Farben - silber-metallic, dunkelgrau-metallic



Kontrollnummer:
Control-number / Contrôle-Qualité / Controlnummer:

Bei Reklamationen bitte anführen:
Kontrollnummer und Artikelnummer des reklamierten Teils.

GB: In case of complaint please indicate the control-number and the number of the item, which is subject of complaint.

F: Pour toutes réclamations: prière de joindre le numéro de contrôle et le numéro d'article de la pièce litigieuse.

NL: Bij reclamaties svp doorgeven: controlnummer en artikelnummer van het desbetreffende onderdeel.



Biohort GmbH
Pürnstein 43, 4120 Neufelden, Österreich
Tel.: +43-7282-7788-0, Fax-DW: 190
E-Mail: office@biohort.at, www.biohort.com



BH-1246-5B-12.15.Bt